



ZOOM STEREO MICROSCOPE

EMZ

Series

**INSTRUCTION
MANUAL**

CONTENTS

NOMENCLATURE AND FUNCTION	2 - 3
UNPACKING, ASSEMBLY, PREPARATION FOR USE	4
Unpacking	
Assembly	
OPERATING PROCEDURES	5 - 7
How to Operate Illuminators	5
Focusing Capability	5 - 6
Precise Focus On Specimen	6
Focusing Procedure	6 - 7
PHOTOGRAPHY AND TELEVISION	7 - 8
Photography	7
Camera Operation	8
Television	8
MAINTENANCE AND CARE	9
Bulb Replacement	
Care	
Cleaning	
SYSTEM DIAGRAM	10 - 13

EMZ Series INSTRUCTION MANUAL

NOMENCLATURE AND FUNCTION

MEIJI EMZ Series

ZOOM STEREO MICROSCOPE

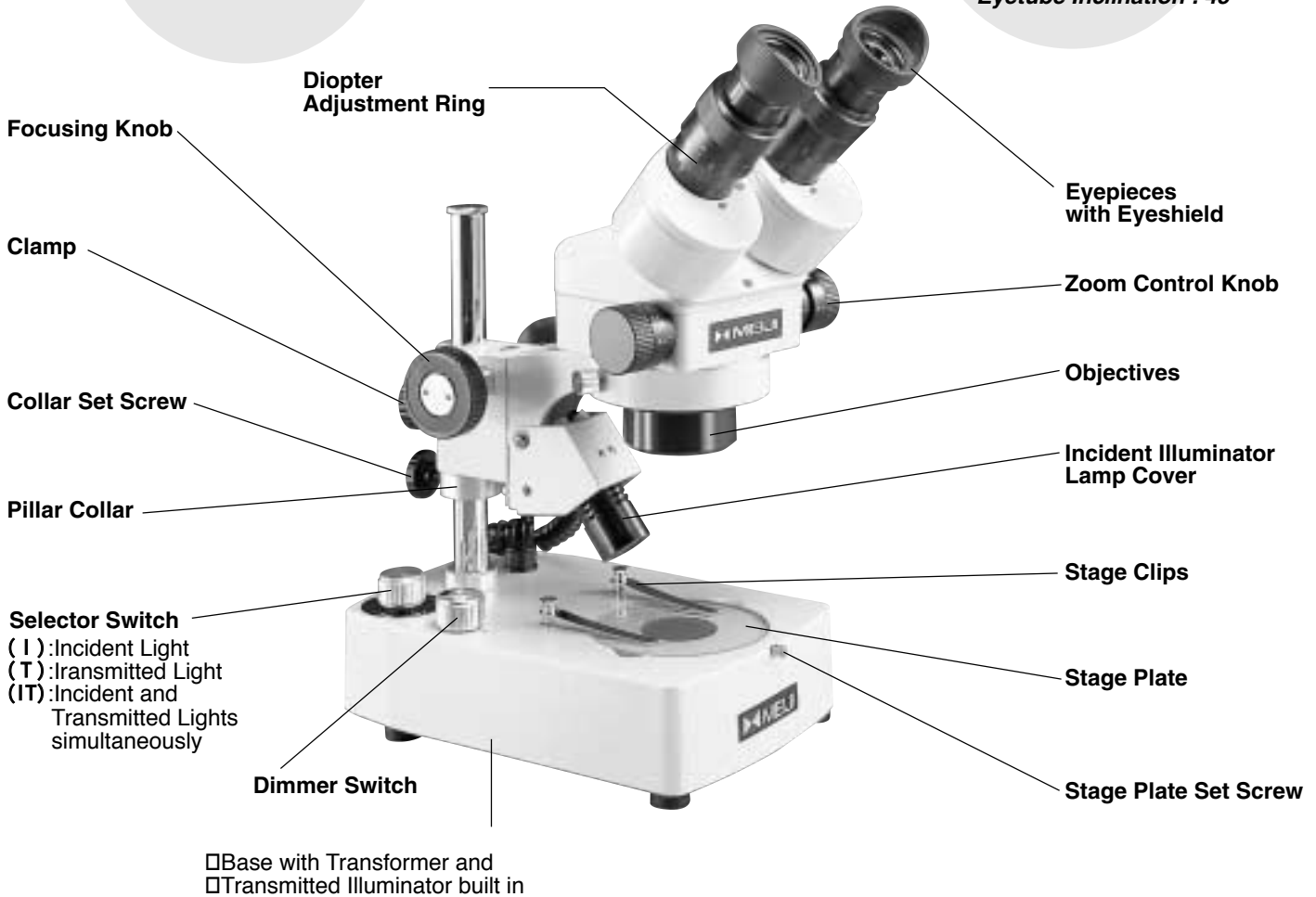
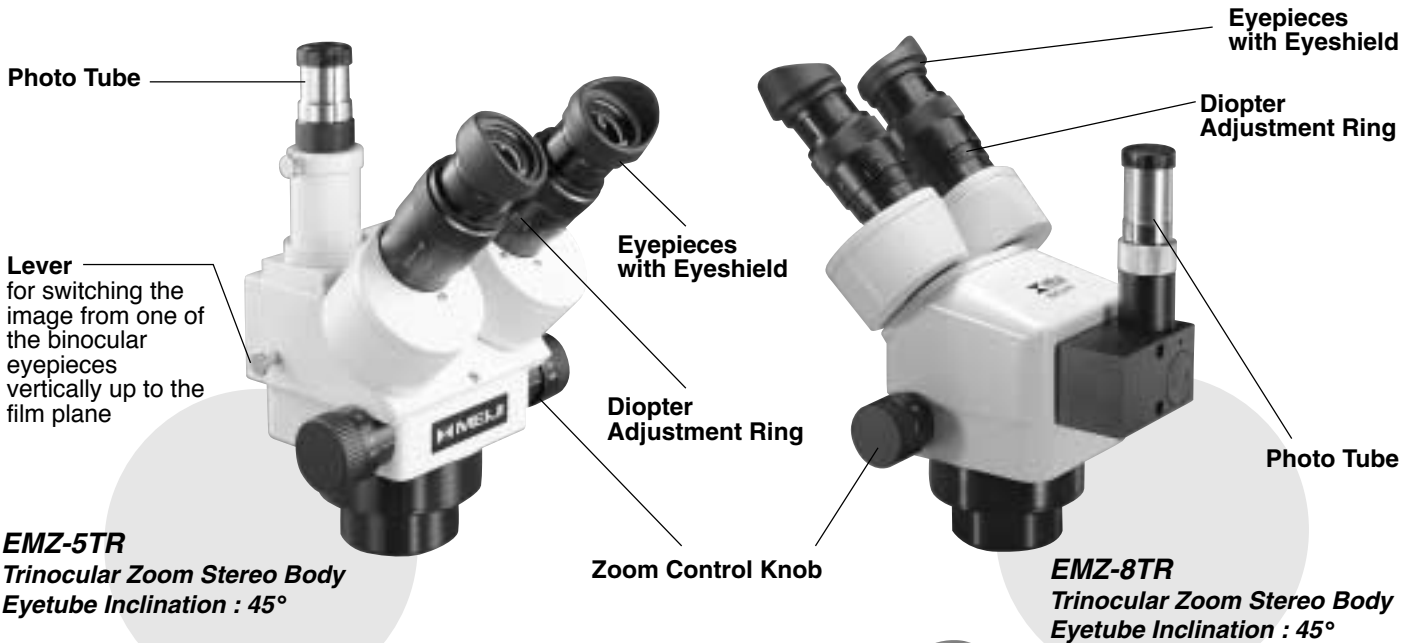

Model EMZ-5 with SWF10X mounted on PBH Stand



EMZ-9
Zoom Stereo Body
Eyetube Inclination : 60°



Z-7100
Zoom Stereo Body
Eyetube Inclination : 90°

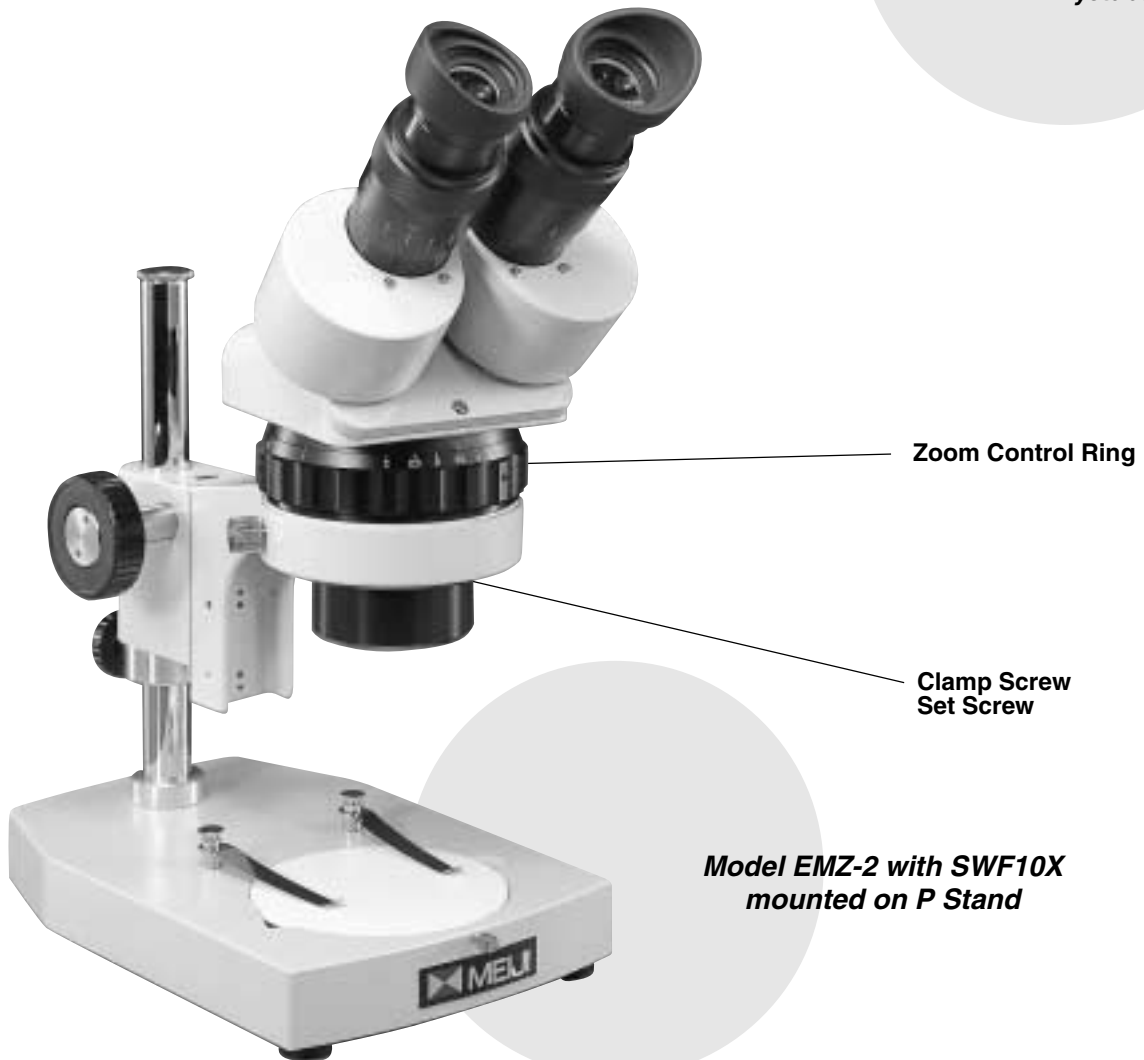

Model EMZ-2 with SWF10X
mounted on P Stand

UNPACKING, ASSEMBLY, PREPARATION FOR USE

UNPACKING

All MEIJI TECHNO microscopes are usually supplied in an expanded polystyrene, 2-part case and this should be used for storage, possible transport in the future, etc. If your order includes a wooden storage cabinet, release the fixing screws holding the limb and base into the cabinet and withdraw.

Unpack the microscope and its parts carefully. Do not discard any boxes or packing materials until the contents of the shipping container have been checked against the packing list sent and your order.

If an EMZ Zoom stereo microscope has been shipped, base, limb and zoom stereo body will be shipped together as a unit. Remove from the styrofoam back, holding the base in one hand and supporting the zoom stereo body with the other.

Place the microscope and parts on a sturdy table or desk which gives firm and stable support. This should be located where the atmosphere is as clean as possible, avoiding places where there is excessive dust, moisture, heat or fumes.

ASSEMBLY

When in place, insert eyepieces in the eyetubes of the binocular body. Zoom stereo body are already in place on the limb, as shipped. Cover with the plastic dust cover supplied until ready for adjustment and use.

If you ordered zoom stereo body and stand separately, loosen the set screw and insert the zoom body into the holder then tighten the set screw after setting at the desired position.

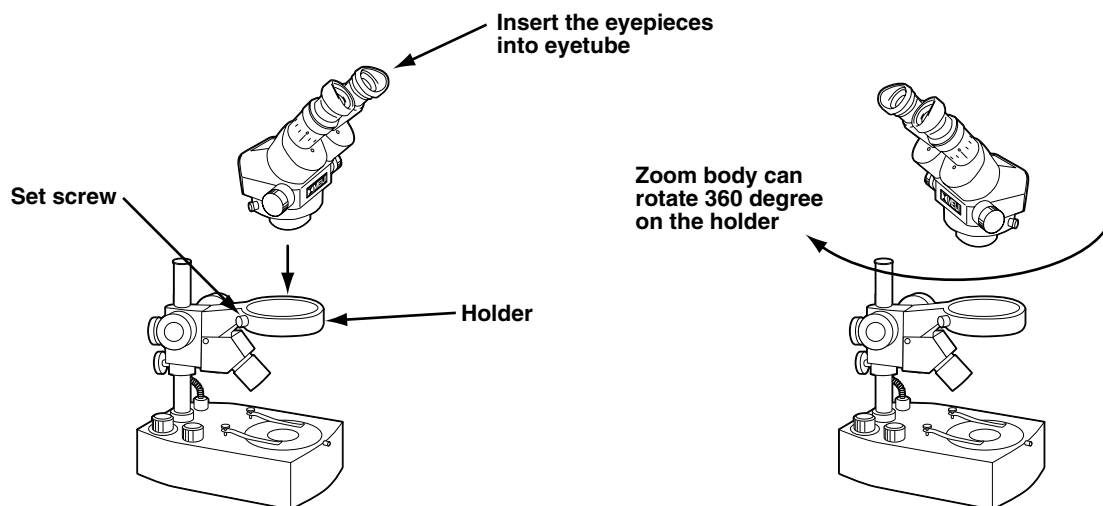

IMPORTANT!

Before plugging the illuminator into any electric outlet, make sure that transformers and illumination bases supplied to you are suitable to the current available. (When shipped, these will be labelled as to mains voltage and cycles specification.)

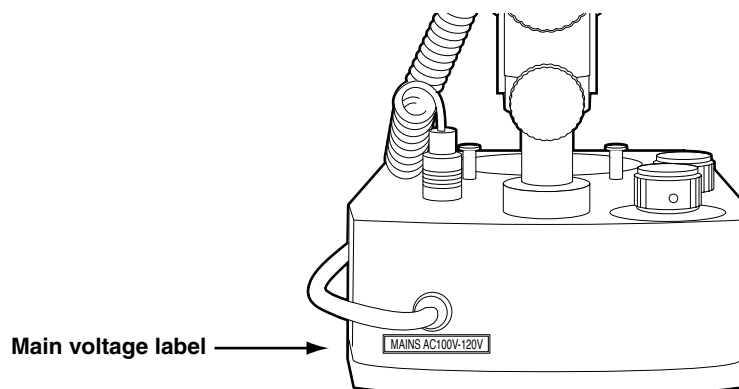

OPERATION PROCEDURES

HOW TO OPERATE ILLUMINATORS

How to use selector switch

□ Focusing stands, PB and ABZ, are using 6V 1.2A (7W) tungsten filament bulb with suitable transformer built-in base and selector switch on the base.

□ Turn the selector switch knob to indicate [I] for oblique illumination, to indicate [T] for transmitted illumination and [IT] for simultaneous illumination by oblique and transmitted lights. The selector switch has OFF position at the both right and left ends.

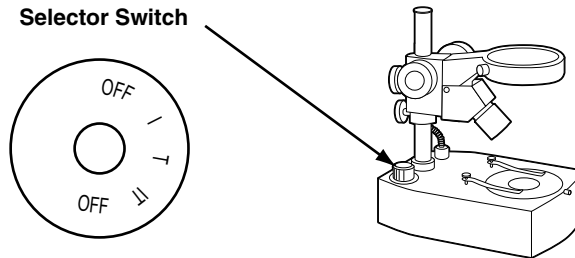

How to use selector switch and dimmer switch

□ Focusing stands, PBH, ABZH and ABE, are using 6V 10W Halogen lamps with suitable transformers built-in base and a selector switch and a dimmer switch on the base.

□ Select an illuminator to use, either incident or transmitted, by the selector switch in the way described above. Then, turn the dimmer switch knob slowly to clockwise to turn the dimmer switch ON and to increase brightness. Turn the knob to counterclockwise to decrease the brightness and to turn OFF.

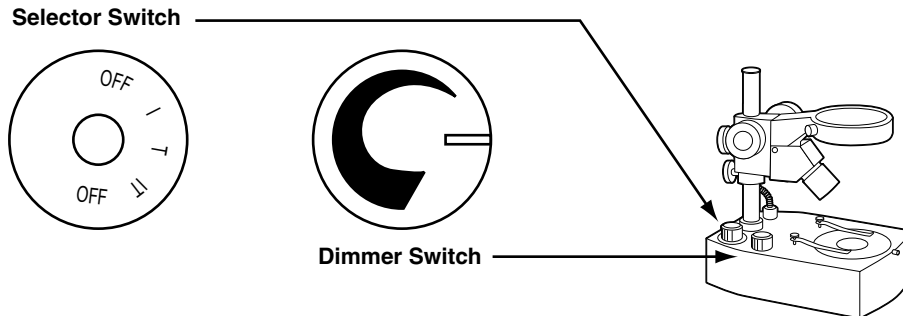

FOCUSING CAPABILITY

The Pole-type focusing stands have a double focusing capability, i.e.

Rough Focus (by sliding the whole focus assembly and zoom body up and down on the pillar, fixing the clamp screw when in approximate focus on your specimen), **Precise Focus** (by using the rack and pinion focusing knob).

The focusing stands, P, PL, PX, PC, PB, PBH and BX are the Pole-type.

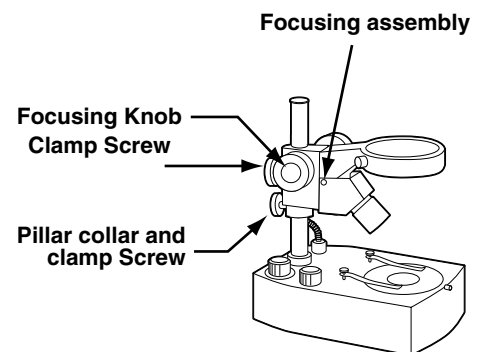

Before moving the whole focus assembly up and down for rough focus, loosen pillar collar once and make sure to reset after the rough focusing is done.

The Rigid arm type focusing stands (except the model ABE) have a focusing capability only by rack and pinion adjustment. This means that the available range of specimen sizes/depths which can be accommodated is somewhat less than in the case of Pole-type stands.

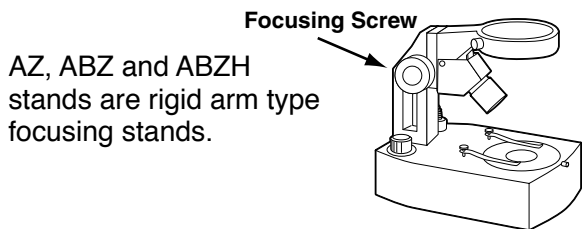

AZ, ABZ and ABZH stands are rigid arm type focusing stands.

The Rigid arm type ABE focusing stand is with integral focus block and extendable working distance. Provides transmitted and incident halogen illumination.

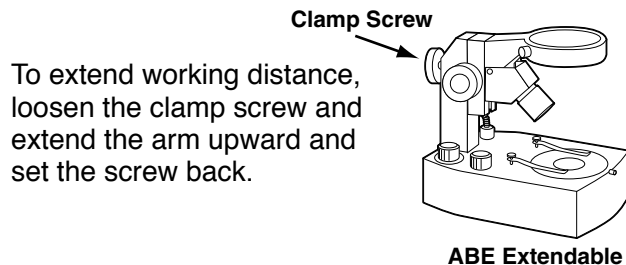

To extend working distance, loosen the clamp screw and extend the arm upward and set the screw back.

ABE Extendable

PRECISE FOCUS ON SPECIMEN

Stage Plates

You should now decide which of the stage plates supplied will be most suitable.

The focusing stands with plain bases, P, PL, PX, PC and A, are supplied with reversible black and white stage plates. Your selection depends on which side, black or white, gives the best contrast conditions with your selected specimen.

The focusing stands with transmitted illuminators, PB, PBH, ABZ, ABZH and ABE, are supplied with clear glass stage plates and reversible black and white stage plates. If the specimen is semi-transparent, the glass stage plate should be used with transmitted illumination switched on. If the specimen is opaque, use the black/white stage. Your selection depends on which side, black and white, gives the best contrast.

When replacing stage plate loosen the set screw which is visible in front of the stage.

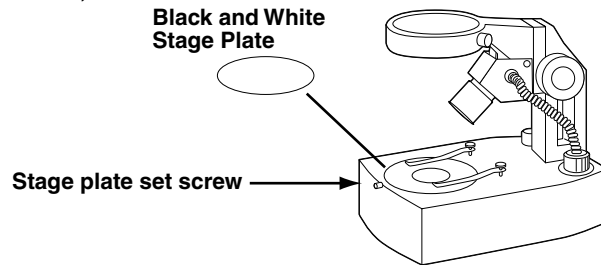

FOCUSING PROCEDURE

The whole point of stereoscopic microscopes is that, when properly adjusted, the observer sees the object image in three dimensions and can perceive height and depths on the specimen. This is a great advantage in material examination and quality control techniques.

To achieve these desirable height/depth effects the images coming from the binocular eyepieces must be "fused" into a single image by the observer - this requires some practice and careful setting of the binocular body. Procedure is as follows:-

The operator should move eyepiece tubes in and out to find the place where the distance between eyepiece centers matches the distance between the pupils of his own eyes. This is the **interpupillary distance** and will vary somewhat from operator to operator. When these distances are equal (or **match**), one central image is seen by the operator.

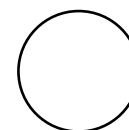
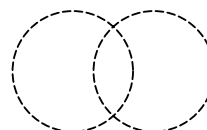
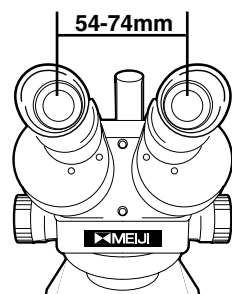

"Fused"

Finally it is necessary to adjust, so focus remains sharp through the whole range of zoom magnification and so that the image is seen equally sharply focused in both right and left-hand eyepieces.

- (1) Set microscope magnification to the highest power 4.5X by turning the zoom control knob counter-clockwise.
- (2) Then focus sharply on the specimen.
- (3) Set to the lowest magnification by turning the zoom control knob clockwise. Do not touch the focusing controls.
- (4) Looking with the right eye through the right-hand eyepiece, turn the eyepiece's diopter adjustment ring until the image is precisely in focus.
- (5) Do the same with the left eye and left-hand eyepiece.
- (6) The fused microscope image should now be uniformly sharp throughout the zoom range and without refocusing.

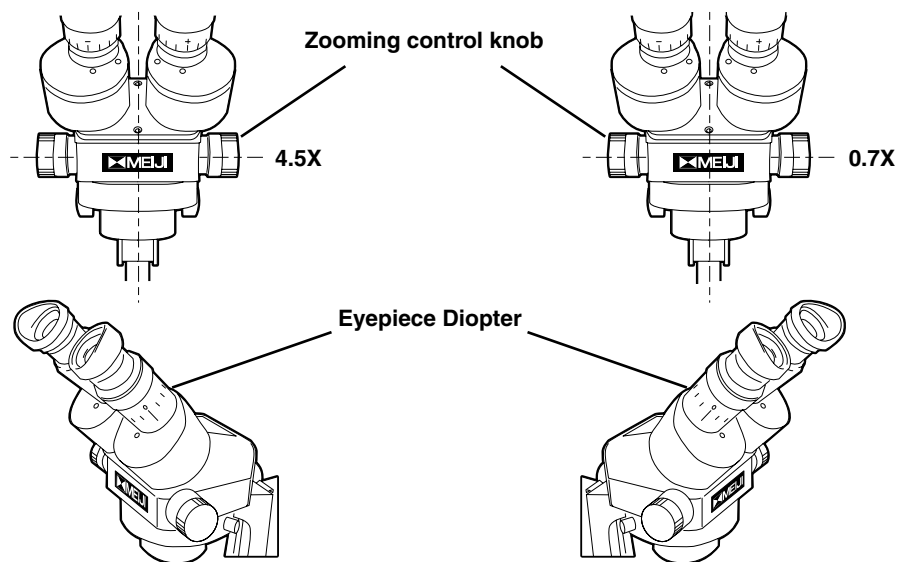

PHOTOGRAPHY AND TELEVISION

PHOTOGRAPHY

Photographic documentation of microscope visual images is most conveniently achieved by using the trinocular (photo-binocular) bodies offered for use with MEIJI TECHNO microscopes.

In the case of the EMZ-TR Zoom Stereo series a trinocular is supplied with lever-switching of the image from one of the binocular eyepieces vertically up to the film plane of a 35mm SLR camera with adaptor mounted on the vertical photo tube. Visual observation can be simultaneously carried out, using the other eyepiece.

In this system the MA150/50 and MA150/60 Camera Attachment should be used with the SLR camera model of your choice. Please note that one of the large range of T2 Adaptor Rings suiting to your camera should have been ordered and supplied.

These adaptor rings are intended to compensate for the small differences in effective distance of the film plane in your camera - so as to ensure that photographs are optimally sharp, and achieved without wastage of film in trial shots and experimentation.

In addition special low-power camera eyepieces (2.5X, 3.3X and 5X) are available and recommended - these will give you maximum field coverage on your specimen while using the convenient and economical 35mm film format

CAMERA OPERATION

- (1) Fix your 35mm SLR camera on the MA150/50 or MA150/60 Camera Attachment, then mounting this assembly on the straight tube of the trinocular body.
- (2) Pull out the lever on your trinocular body so as to send the image both to the camera and the visual eyepiece.
- (3) Rotate the adjustment ring on the straight tube so as to set the red indicator line on the upper tube portion at the top edge of the lower tube. Then fix in place with the clamp screw. You now should be set correctly for optimum conditions of simultaneous visual observation and photography.

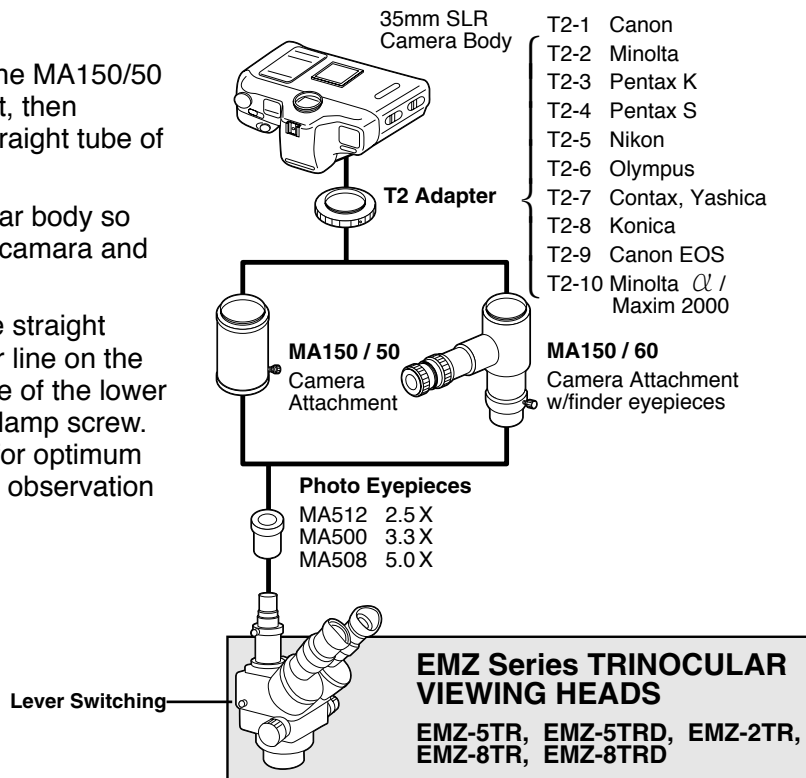

TELEVISION

For television the MA 151/5N (EMZ-TR) "C" Mount Adaptor should be used, threaded into your TV camera, then placed and adjusted on the upper portion of your trinocular body.

Adjustment can then proceed a per paragraph (3) above. You should understand that the comparatively large magnification factors inherent in most TV camera/monitor systems will restrict your fields of view (while blowing up total magnification).

A correct optical set-up and adjustment is, of course, crucial to obtaining a good TV monitor image, but keep in mind that the monitor controls for brightness and contrast adjustment are also important and should also be experimented with in order to obtain the best monitor image.

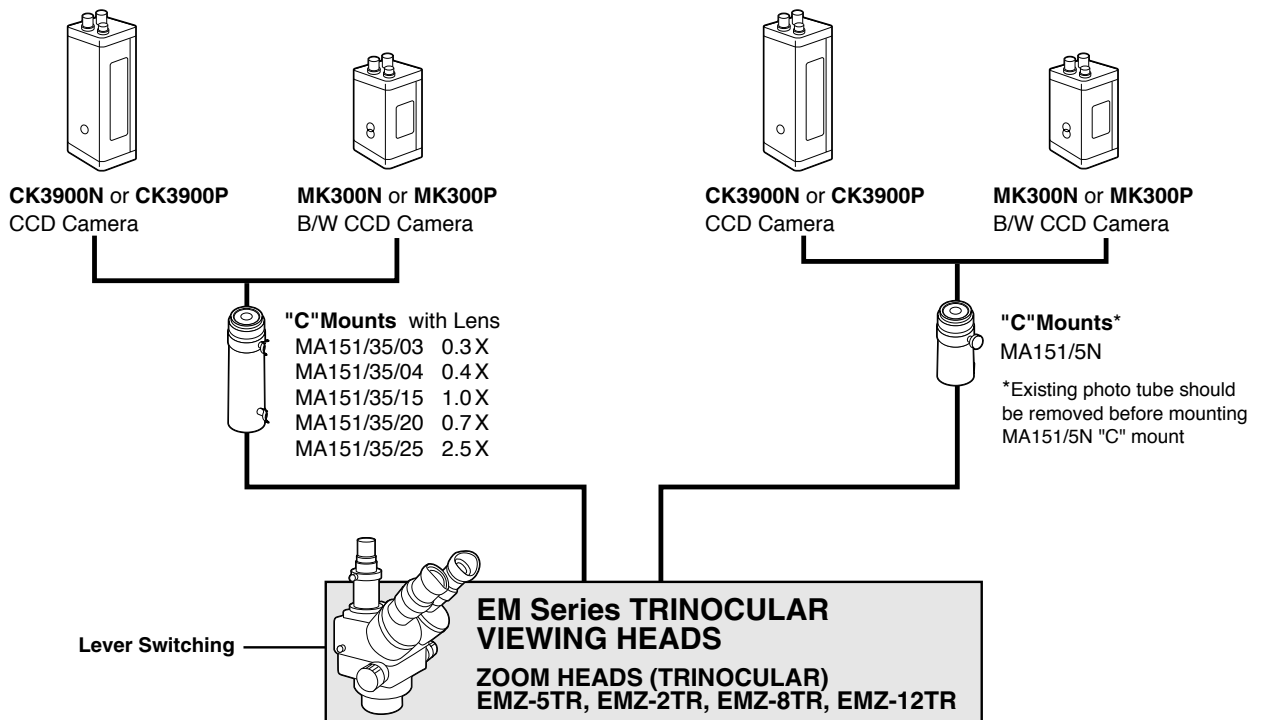

MAINTENANCE AND CARE

BULB REPLACEMENT

When changing light bulbs in the illuminators, always disconnect the plug from the electrical source. Never work on the electrical system without first disconnecting.

When a bulb replacement is necessary in the Incident Illuminator, remove the lamp cover by turning it counterclockwise and remove the old bulb by twisting it 1/3 turn counterclockwise by pushing it toward the socket so that the bulb will be sprung out from its socket.

To replace the bulb of the Transmitted Illuminator, lay the instrument carefully over on its side and remove the four set screws in the bottom cover of the base. Replace the old bulb in the same way as above.

The bulbs used for the Incident and Transmitted Illuminators of PB/ABZ stand are different. The bulb for the Incident Illuminator employs a flat filament facing to the head of the bulb and Catalog Number is MA560 and the bulb for the Transmitted Illuminator employs a flat filament facing to the side of the lamp and the Catalog Number is MA561. The bulbs used for the Incident and Transmitted Illuminators of PBH/ABZH/ABE stand are same halogen. Catalog number is MA570.

● Transmitted bulb replacement

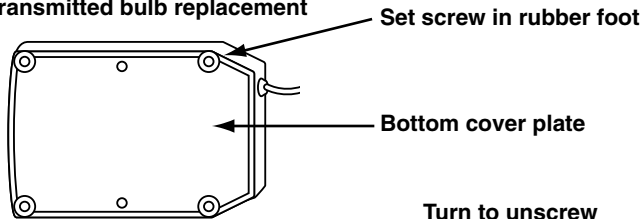

● Incident bulb replacement

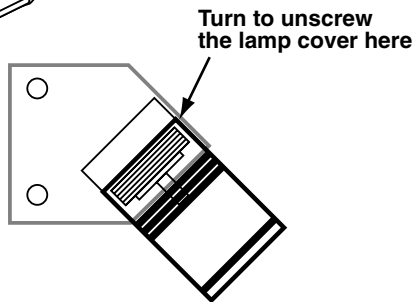

● For Incident light MA560

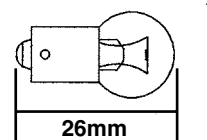

● For Transmitted light MA561

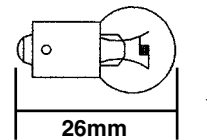

● For Both light MA570

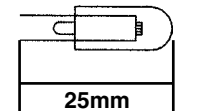

PB
ABZ Stands

PBH
ABZH
ABE Stands

CARE

Always cover the instrument with the plastic dust cover provided when the microscope is not in use.

Keep the eyepieces in the microscope body at all times in order to prevent dust from falling on the internal optics.

Store the microscope in a safe, clean place when not in use for an extended period of time.

CLEANING

Clean exposed lens surfaces carefully with a pressurized air source, soft brush or clean soft cloth.

Too much finger pressure may damage lens coatings.

To remove oil fingerprints and grease smudges, moisten the cleaning cloth with a very small amount of alcohol or xylene.

Painted or plastic surfaces should be cleaned only with a cloth moistened with water and a small amount of detergent.

DO NOT ATTEMPT TO MAKE ADJUSTMENTS TO THE INTERNAL OPTICS OR MECHANICS!!

If the microscope does not seem to be functioning properly or you have questions about its operation, call your supplier (or an authorized repair service) for advice.

EM Series SYSTEM DIAGRAM

ZOOM MODELS

Photo/Video attachments are show in Page 13

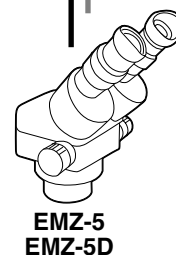
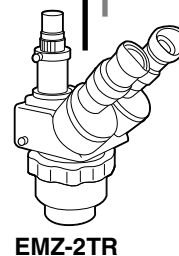
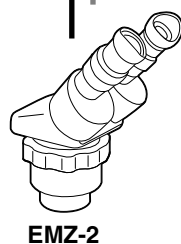
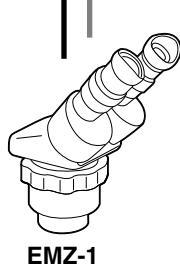
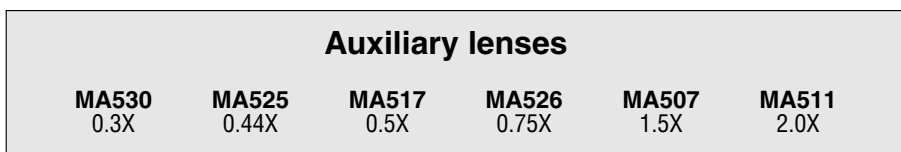

STAND

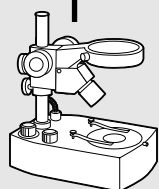

PBH Pole type
w/halogen 6V 10W
trans/incident

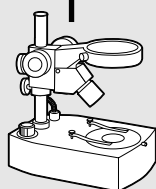

PB Pole type
w/tungsten 6V 7W
trans/incident lights

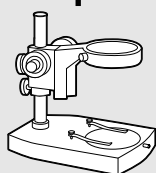

PC Plain Pole
w/coaxial focusing

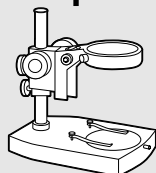

PX Pole type
w/illuminator port
10° Piller

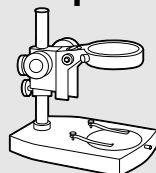

PL Pole type
w/illuminator port

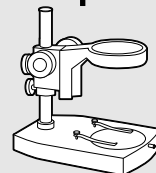

P Plain Pole type

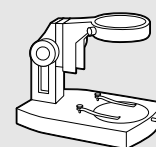

AZ Plain Rigid-arm

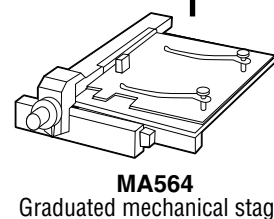
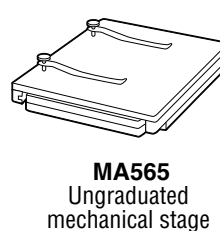
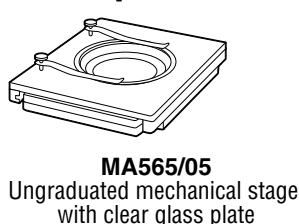
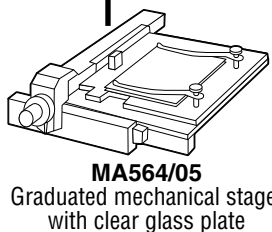
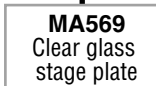
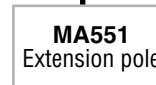
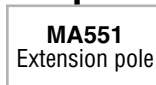
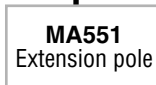
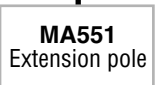
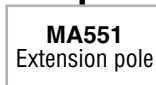
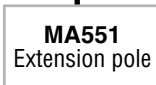

EYEPIECES, Paired

MA501
SWF5X

MA502
SWF10X

MA520
SWF12.5X

MA503
SWF15X

MA535
HSWF15X

MA504
SWF20X

MA521
SWF30X

MA519*
SWF10X-F
*(Piece)

MA600
EYESHIELD

Auxiliary lenses

MA791 0.28X
MA792 0.35X
MA794 0.5X
MA795 1.5X

Auxiliary lenses

MA545 0.3X
MA558 0.44X
MA546 0.5X
MA547 0.75X
MA548 1.5X
MA549 2.0X

Auxiliary lenses

MA652 0.7X
MA796 0.57X

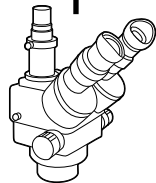

EMZ-5TR
EMZ-5TRD

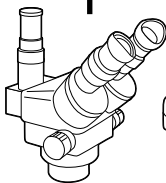

EMZ-8TR
EMZ-8TRD

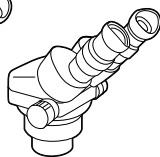

EMZ-6

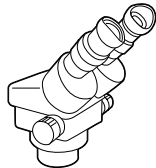

EMZ-9

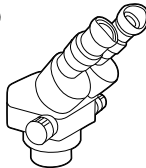

EMZ-10

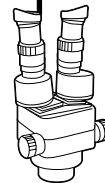

Z-7100

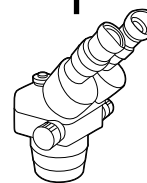

EMZ-12
EMZ-12D

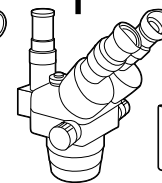

EMZ-12TR
EMZ-12TRD

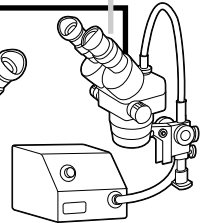

EMZ-12
FL150 and FL150/12

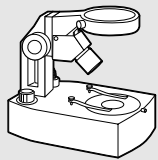

ABZ Rigid-arm
w/tungsten 6V 7W
trans/incident lights

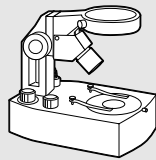

ABZH Rigid-arm
w/halogen 6V 10W
trans/incident lights

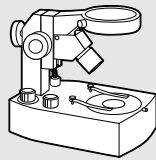

ABE Extendable
w/halogen 6V 10W
trans/incident lights

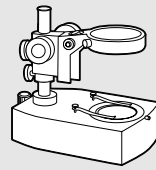

BX Stand
w/mirror for B/D
(light not included)

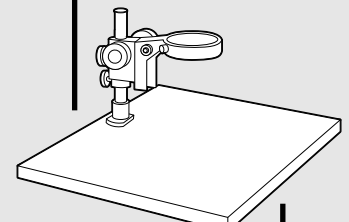

KBL Pole type
w/illuminator port
on flat base

MA551
Extension pole

MA567
Acrylic frosted
stage plate

MA567
Acrylic frosted
stage plate

MA567
Acrylic frosted
stage plate

MA551
Extension pole

MA569
Clear glass
stage plate

MA569
Clear glass
stage plate

MA569
Clear glass
stage plate

MA567
Acrylic frosted
stage plate

MA569
Clear glass
stage plate

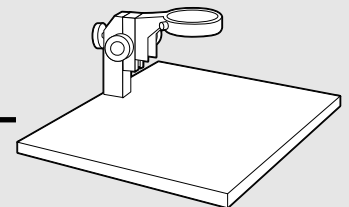

KBE Rigid-extendable
arm on flat base

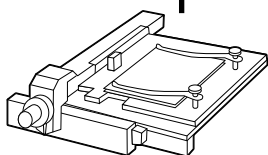

MA564/05
Graduated mechanical stage
with clear glass plate

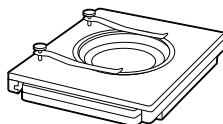

MA565/05
Ungraduated mechanical stage
with clear glass plate

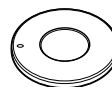

MA667
Polarizing Plate
(Polarizer)

EM Series SYSTEM DIAGRAM

SPECIAL STANDS

ZOOM HEADS

EMZ-1, EMZ-2, EMZ-5, EMZ-5D, EMZ-6, EMZ-9,
EMZ-10, Z-7100, EMZ-2TR, EMZ-5TR, EMZ-5TRD,
EMZ-8TR, EMZ-8TRD

EMF, EMT VIEWING HEADS: EMF-1, EMF-2,
EMT-1, EMT-2, EMT-3, EMT-4,
EMTR-1, EMTR-2, EMTR-3, EMTR-4,

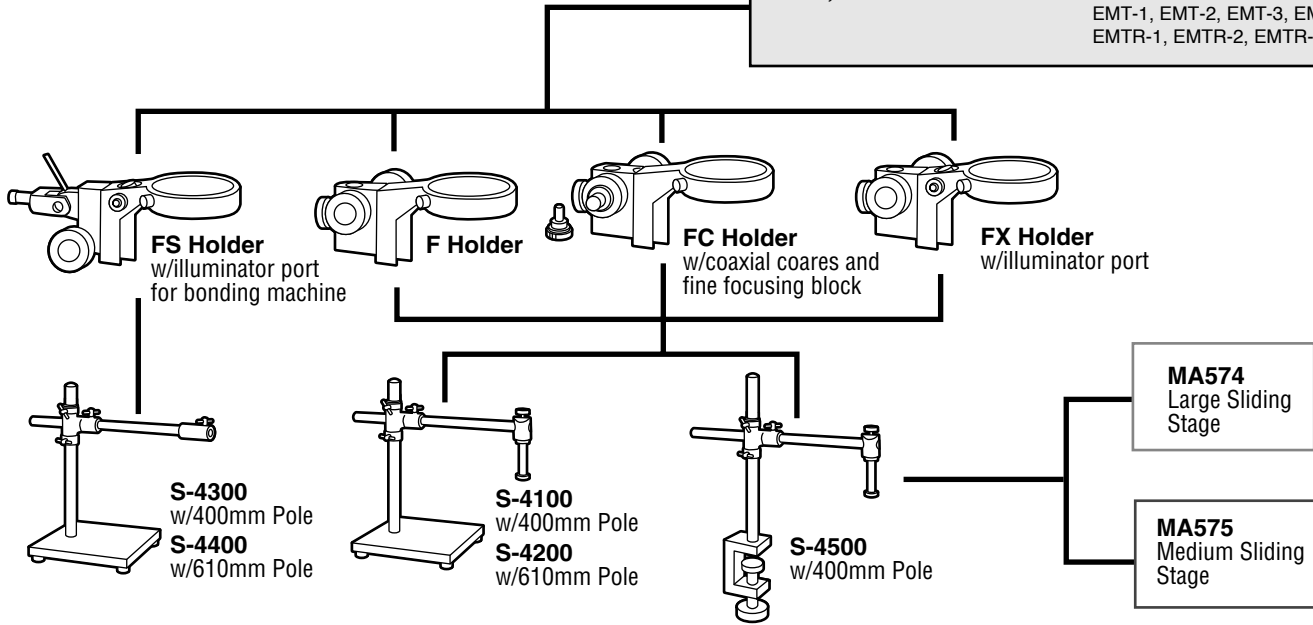

ZOOM HEADS

EMZ-1, EMZ-2, EMZ-5, EMZ-5D, EMZ-6, EMZ-9,
EMZ-10, Z-7100, EMZ-2TR, EMZ-5TR, EMZ-5TRD,
EMZ-8TR, EMZ-8TRD

EMF, EMT VIEWING HEADS: EMF-1, EMF-2,
EMT-1, EMT-2, EMT-3, EMT-4,
EMTR-1, EMTR-2, EMTR-3, EMTR-4,

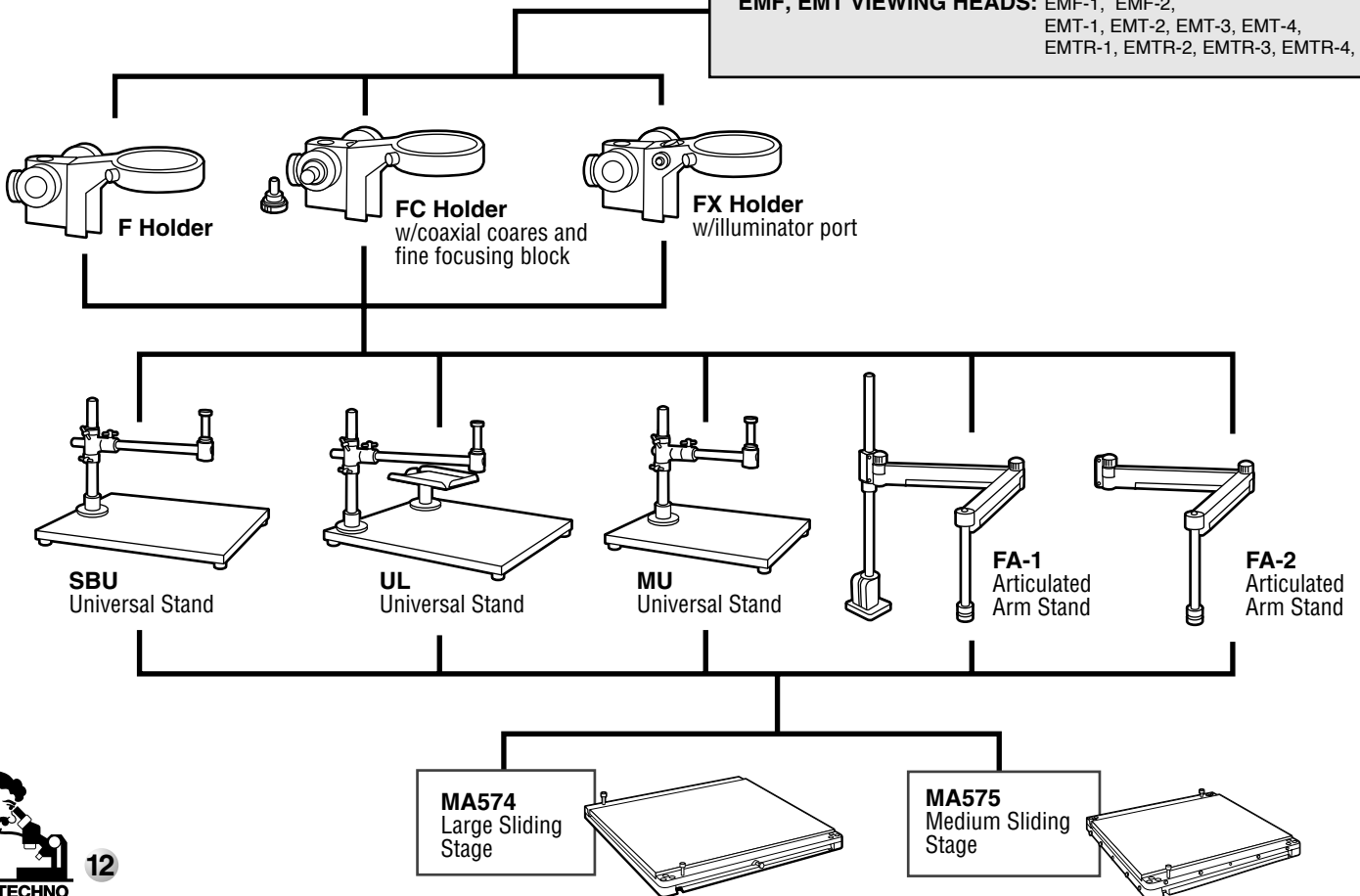

EM Series SYSTEM DIAGRAM

VIDEO MICROSCOPY

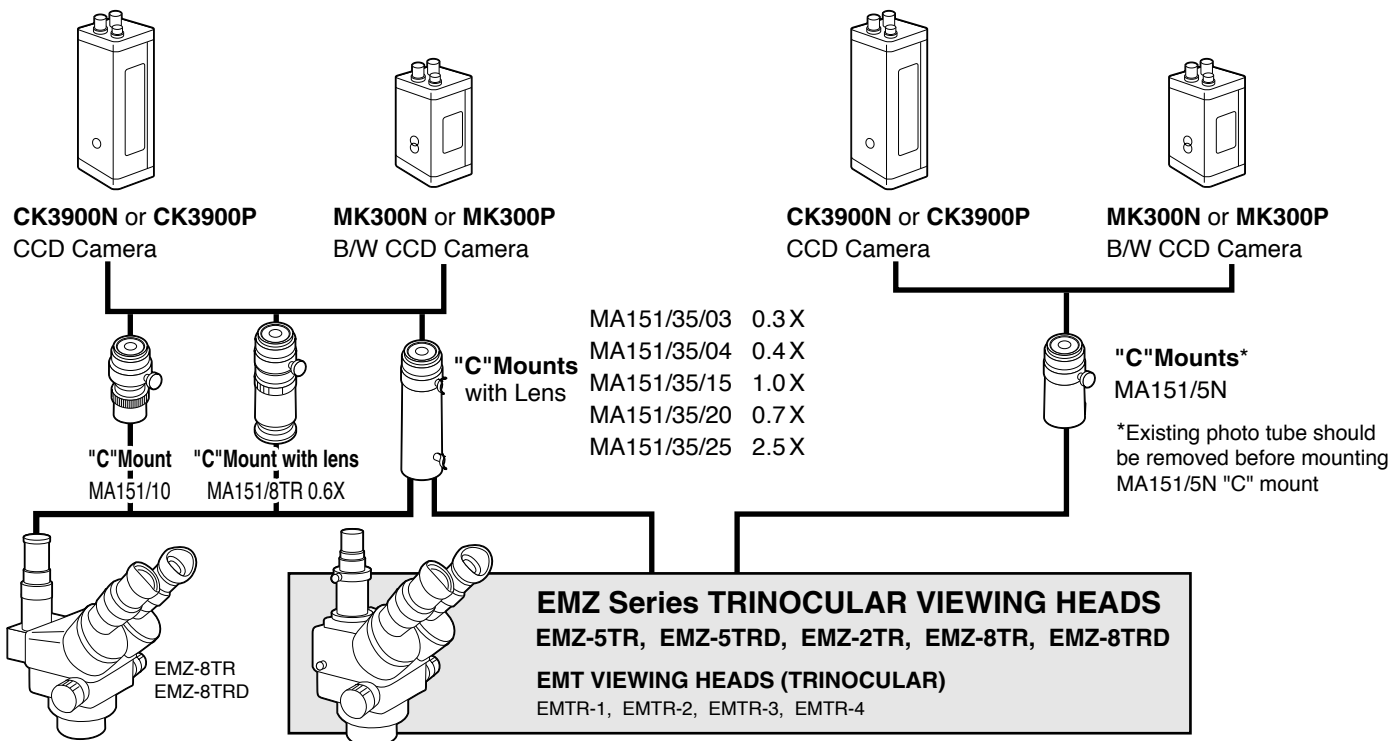

EM Series SYSTEM DIAGRAM

PHOTO MICROSCOPY

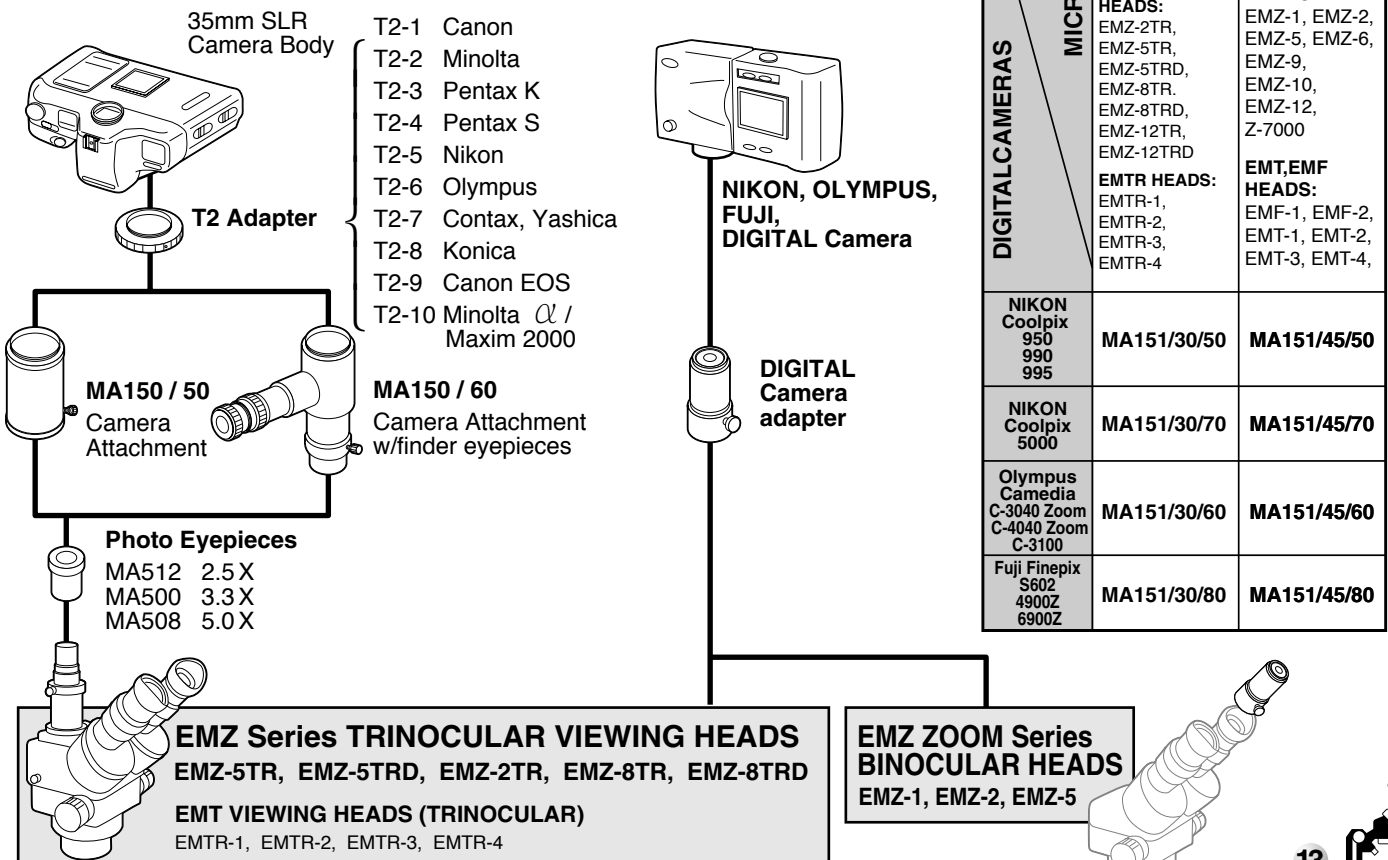



MEIJI TECHNO CO.,LTD.

322-1,Chikumazawa Miyoshi-machi, Iruma-gun

Saitama 354-0043, Japan

E-mail : meiji@meijitechno.co.jp

Phone : (0)49-259-0111 Fax : (0)49-259-0113

MEIJI TECHNO AMERICA

2186 Bering Drive San Jose, CA., 95131, USA

E-mail : sales@meijitechno.com

Phone : 408-428-9654 Fax : 408-428-0472

Toll free : 800-832-0060

<http://www.meijitechno.com>

