

ZOOM STEREO MICROSCOPES

RZ Series

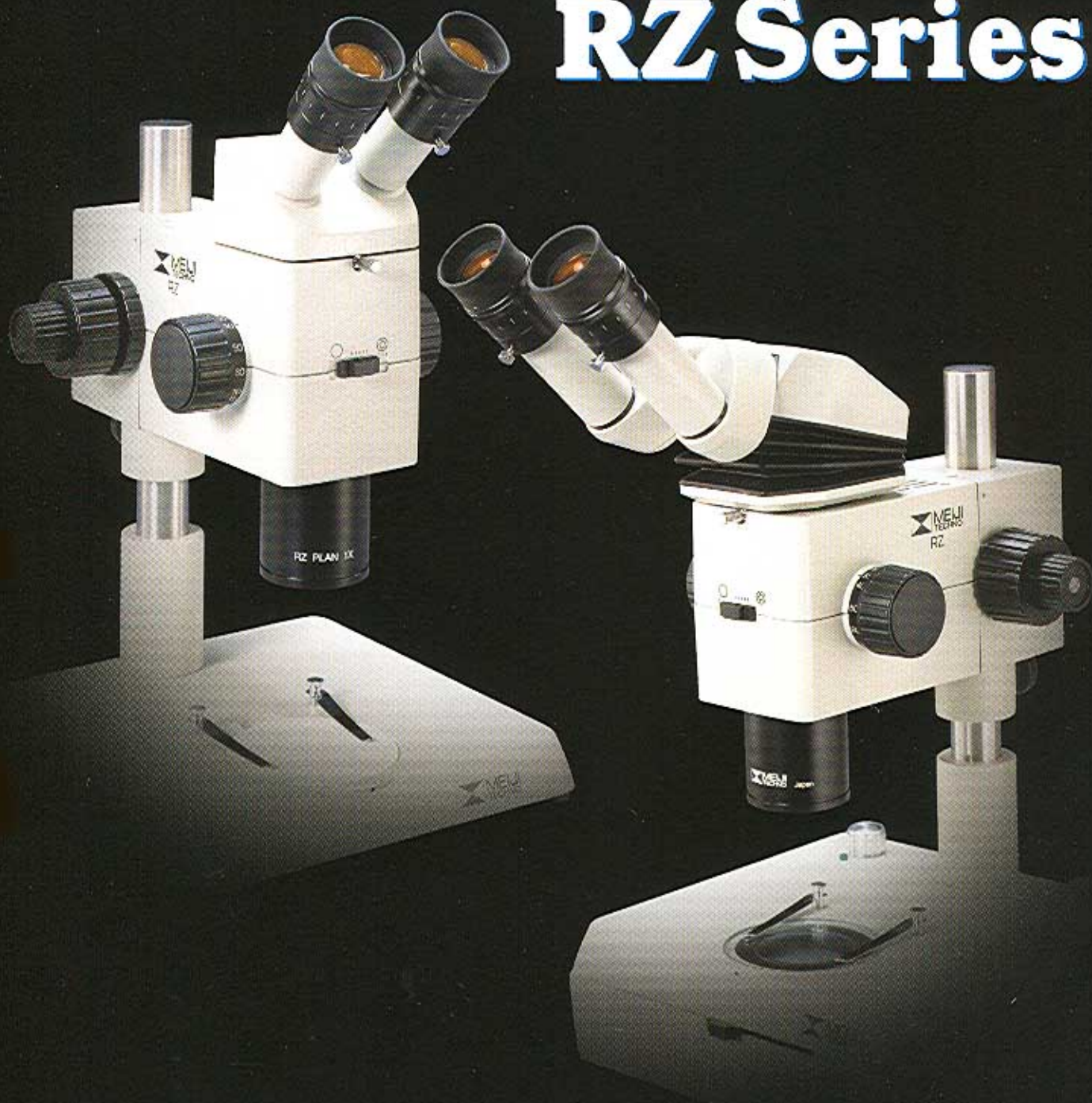

The "MEIJI TECHNO" RZ Series of advanced, high performance, modular, stereo microscopes are specifically designed with today's demanding applications in mind.



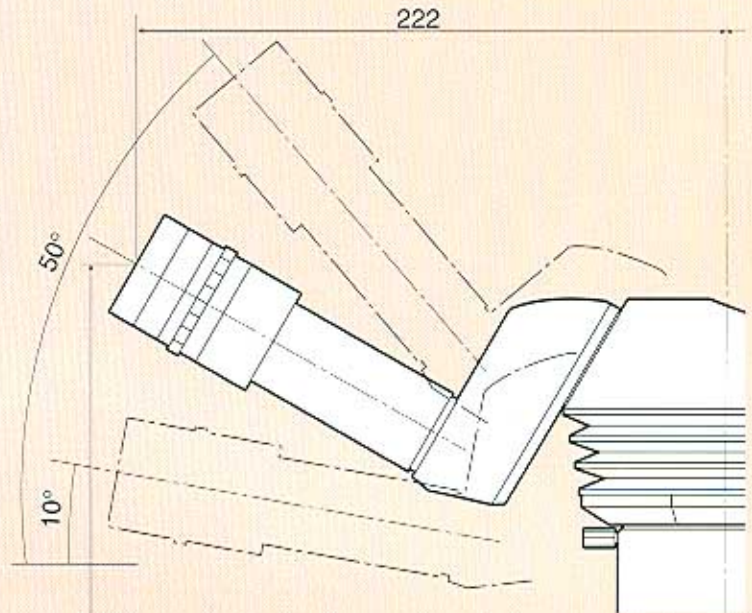
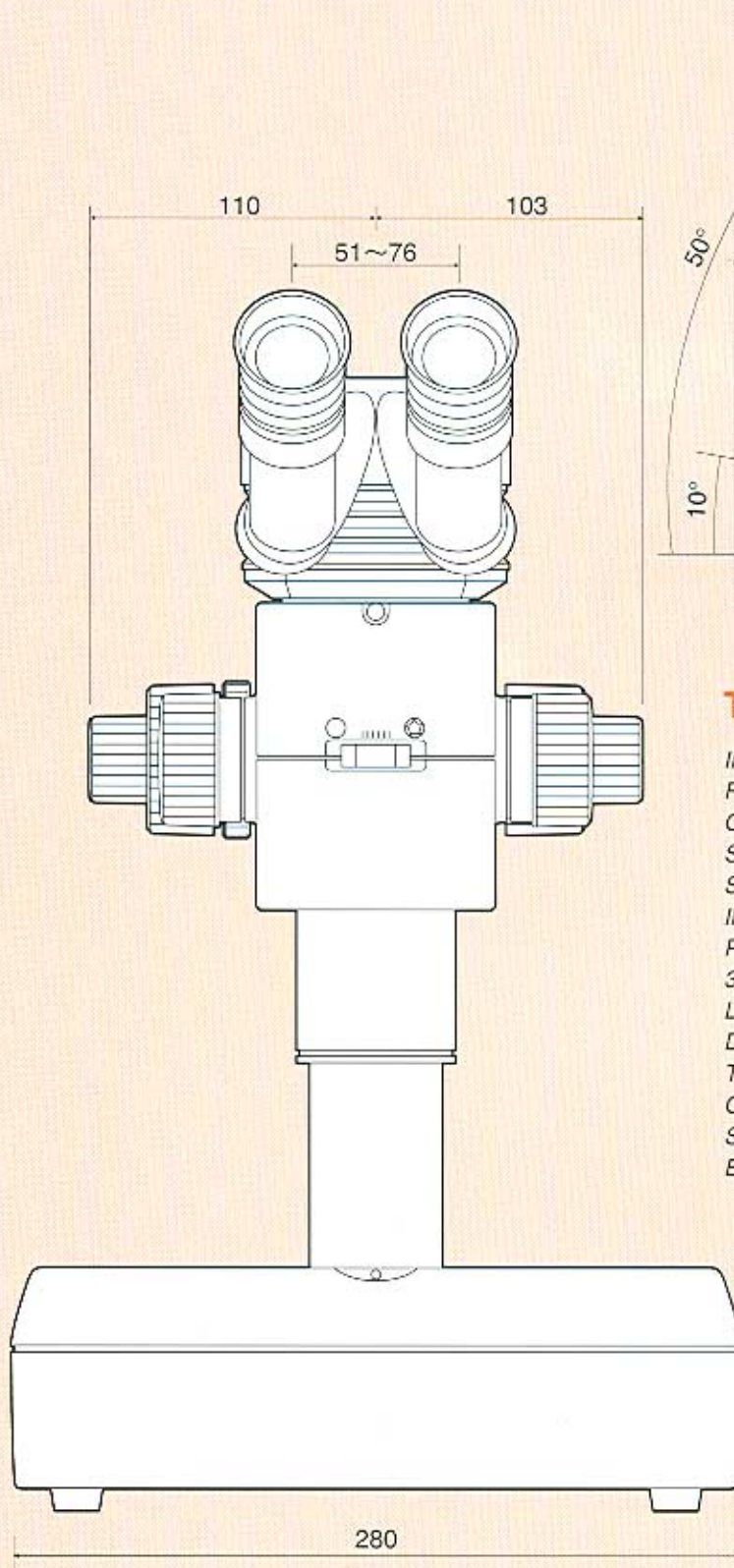

TABLE OF CONTENTS

<i>Introduction</i>	Page 2
<i>Parallel Optical System</i>	Page 3-4
<i>Optical Components</i>	Page 5-6
<i>Stands</i>	Page 7-8
<i>Stages</i>	Page 9-10
<i>Illumination</i>	Page 11-12
<i>Photo and Video Equipment</i>	Page 13-14
<i>35mm Photography Equipment</i>	Page 15
<i>Large Format Photography Equipment</i>	Page 16
<i>Drawing and Measuring Components</i>	Page 17
<i>Table of Magnifications</i>	Page 18
<i>Catalog Numbers</i>	Page 19-20
<i>Sample Configurations</i>	Page 21-24
<i>Exploded View System Diagram</i>	Page 25-26

ZOOM STEREO MICROSCOPES

RZ Series STEREO MICROSCOPES

The MEIJI TECHNO RZ Series of advanced, high performance, modular, stereo microscopes are specifically designed with today's demanding applications in mind.

Engineered around a Common Main Objective and parallel optical paths, the RZ Series offers crisp, distortion-free, high-resolution images at magnifications ranging from 3.75X to 300X.

Featuring a 10:1 zoom ratio, built-in variable double-iris diaphragms, and positive détente click-stops at 12 positions of magnification. Two perpendicular columns of eight zoom lenses in four groups move in a smooth continuous motion by rotation of the ergonomically sized and positioned zoom control. A magnification indicator is conveniently located on the zoom control. The RZ Series is also coated with a special anti-static finish, which is especially useful when working with sensitive electronic components.

Ergonomic and standard heads are available. The ergonomic head features low positioned eyetubes and is adjustable vertically from 10° to 50° for comfortable, fatigue-free viewing. Interpupillary distance is adjustable from 52mm to 75mm. The standard economical binocular head is inclined at 45° with an interpupillary adjustment ranging from 46mm to 75mm.

Distortion-free, ultra widefield eyepieces with dioptric adjustment are available in several powers of magnification and are provided with reticle mounts for measurement and photomicrography.

A coaxial coarse and fine focus mechanism with a 50mm focusing range is provided for ultra-smooth and precise focus control.

MEIJI TECHNO's RZ Series offers a full range of optional modular accessories including: Ergonomic Binocular Body, Coaxial Vertical Illuminator, TV Camera Adapter, Drawing Attachment, Multiple Interchangeable Objectives and Widefield Eyepieces, Polarizing Filters, Brightfield Transmitted Light Stand, Brightfield/Darkfield Transmitted Light Stand, Photomicrographic Systems and various other components and accessories for complete system versatility.

A PARALLEL OPTICAL SYSTEM

The RZ Series is a modular stereo microscope, which means you can build a system to meet your needs and your budget. The heart of the system is the RZ-B zoom stereo body with a double iris diaphragm and 1:10 zoom range. Add to this your choice of objectives, viewing heads, eyepieces, stands and a host of other accessories and you can create instruments for a wide variety of specialized applications.

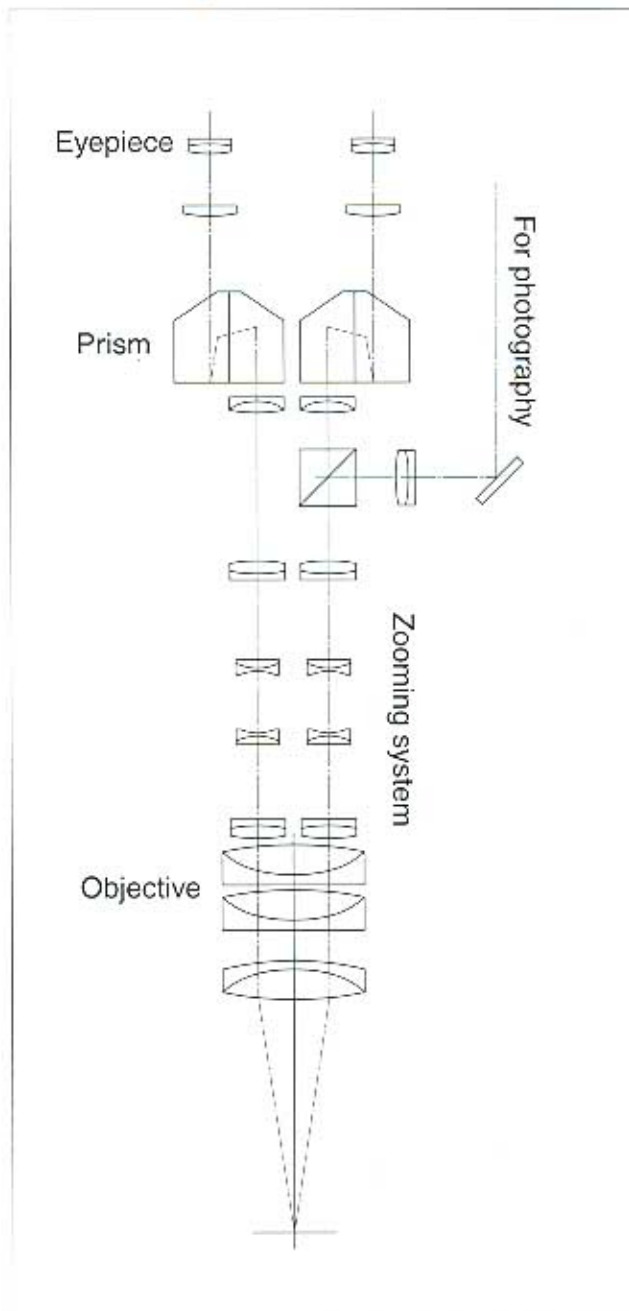

The RZ Series is designed around two parallel optical paths which pass through a common main objective. This infinity system design allows for the quick change and easy introduction of intermediate optical components such as an independent beam-splitter, coaxial illuminator, drawing tube, video or photo attachment which results in an instrument which can be configured for a wide range of applications.

SPECIFICATIONS

TYPE:

*Common Main Objective (CMO)
Parallel Zoom System*

TOTAL MAGNIFICATION:

*From 3.75X to 300X
(With optional eyepieces and objectives)*

EYEPIECES:

*Ultra Wide Field, focus-able, 10X
Ultra Wide Field, focus-able, 15X
Ultra Wide Field, focus-able, 20X
(10X, 15X, 20X accept reticles)*

OBJECTIVES:

*Plan Achromat 0.5X
Plan Achromat 0.7X
Plan Achromat 1.0X
Plan Achromat 1.5X
Plan Achromat 2.0X*

ZOOM RATIO: 1:10

OPTICAL VIEWING HEADS:

*Standard 45° Binocular
Adjustable Ergonomic, Range 10° to 50°*

ZOOM STEREO MICROSCOPES



Configuration:

- MA749 Ergonomic viewing head
- RZ-B 10:1 Zoom body with built-in dual iris diaphragm and click stops
- MA730 UWF10X Eyepieces (2)
- MA742 1.0X Plan Achromat Objective
- RZDT Brightfield/Darkfield Transmitted light Stand (6V, 30W Halogen)

OPTICAL COMPONENTS

VIEWING HEADS

Either standard or ergonomic viewing heads are available for the RZ stereo microscope.

The standard head is inclined at 45° with an interpupillary distance adjustment ranging from 46mm to 75mm.

Catalog Number: MA748

The ergonomic head features low positioned eyetubes with adjustable inclination from 10° to 50° for comfortable fatigue-free viewing. The interpupillary distance is adjustable from 52mm to 75mm.

Catalog Number: MA749

BODY

The RZ body features a 10:1 zoom ratio, built-in variable double iris diaphragms, and positive detente click-stops at twelve positions of magnification. Two perpendicular columns of eight zoom lenses in four groups move in a smooth continuous motion by rotation of the ergonomically sized and positioned zoom control. A magnification indicator is conveniently located on the zoom control.

Model: RZ-B



MA748 STANDARD VIEWING HEAD

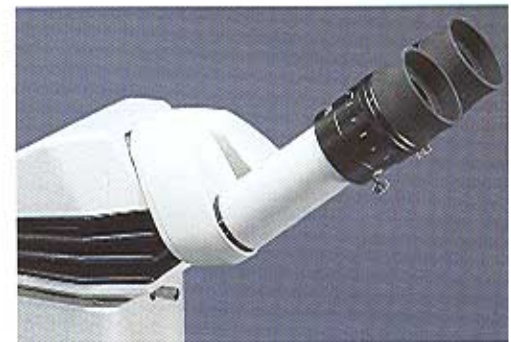

MA749 ERGONOMIC VIEWING HEAD



RZ-B BODY

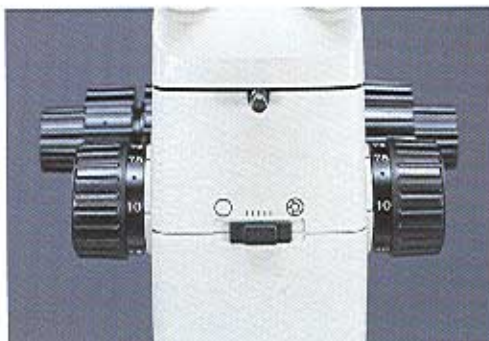

DOUBLE IRIS DIAPHRAGM



ZOOM CONTROL WITH MAGNIFICATION INDICATOR

ZOOM STEREO MICROSCOPES

OPTICAL COMPONENTS

EYEPIECES

Distortion-free, ultra widefield eyepieces with dioptric adjustment of plus or minus 5 diopters are available in powers of 10X, 15X and 20X. All eyepieces are provided with reticule mounts, and are also available with a crossline reticle factory installed.



Catalog Number	Description and Magnification	Field Number	Eye-Relief	Focal Length
MA730	UWF 10X	24	21mm	25.0mm
MA731	UWF 10X w/crossline	24	21mm	25.0mm
MA732	UWF 15X	16	17mm	16.6mm
MA733	UWF 15X w/crossline	16	17mm	16.6mm
MA734	UWF 20X	12	12mm	12.5mm
MA735	UWF 20X w/crossline	12	12mm	12.5mm

OBJECTIVES

High resolution, flat field, plan-achromatic common main objectives are available in the following magnifications: 0.5X, 0.75X, 1.0X, 1.5X and 2.0X



Catalog Number	Description	Working Distance
MA740	Plan Achromat Objective 0.5X	164mm
MA741	Plan Achromat Objective 0.75X	101mm
MA742	Plan Achromat Objective 1.0X	76mm
MA743	Plan Achromat Objective 1.5X	43mm
MA744	Plan Achromat Objective 2.0X	29mm

STANDS FOR THE RZ Series

RZP PLAIN STAND

The RZP plain stand consists of an anti-static finished aluminum alloy base with a 95mm diameter black and white plastic stage plate and two stage clips.

Base Dimensions: 280mm wide x 255mm deep x 35mm high
Pillar Height: 325mm



RZP

RZT TRANSMITTED LIGHT STAND

The RZT transmitted light stands are used for brightfield observation of transparent specimens. The RZT features a 6V, 30W halogen lamp with variable intensity control, 95mm diameter clear glass stage plate, two stage clips and an anti-static finish. A second transformer is incorporated into the base for use with the optional COX illuminator or auxiliary light source.

Base Dimensions: 280mm wide x 255mm deep x 85mm high
Pillar Height: 325mm

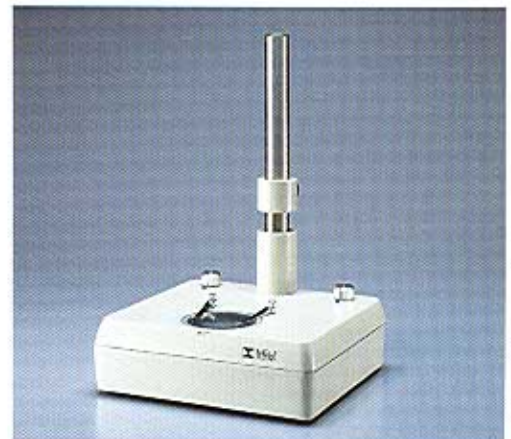

RZT

RZDT BRIGHTFIELD/DARKFIELD TRANSMITTED LIGHT STAND

The RZDT transmitted light stands are used for brightfield/darkfield observation of transparent specimens. The RZDT features a 6V, 30W halogen lamp with variable intensity control, 95mm diameter clear glass stage plate, two stage clips and an anti-static finish. Quick change over from brightfield to darkfield observation is facilitated by easy to reach front mounted controls. A second transformer is incorporated into the base for use with the optional COX illuminator or auxiliary light source.

Base Dimensions: 280mm wide x 255mm deep x 85mm high
Pillar Height: 325mm

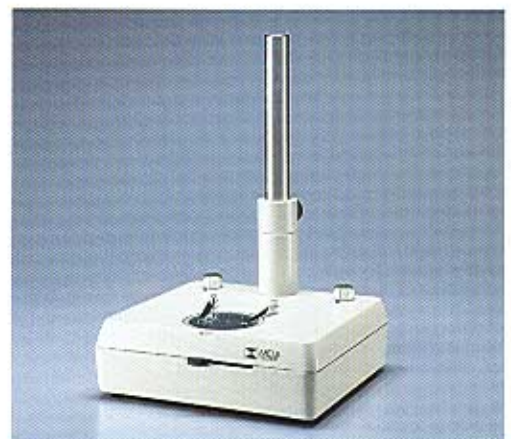

RZDT

ZOOM STEREO MICROSCOPES

STANDS FOR THE RZ Series

RZBD BRIGHTFIELD/DARKFIELD TRANSMITTED LIGHT STAND

The RZBD transmitted light stand is used for brightfield/darkfield observation of transparent specimens. The RZBD stand incorporates an annular fiber optic light guide and an external 150W halogen light source. The RZBD stand features an anti-static paint-coated aluminum alloy base which includes a 95mm diameter clear glass stage plate, two stage clips and a built-in brightfield/darkfield baffle. Quick change over from brightfield to darkfield observation is facilitated by easy-to-reach front-mounted controls.

Base Dimensions: 280mm wide x 255mm deep x 85mm high

Pillar Height: 325mm

Light Source Dimensions: 150mm wide x 230mm deep x 130mm high

Model No. RZBD/100 (110 Volt), RZBD/200 (220/240 Volt)

Replacement Bulb: Cat. No. FL180/70, 21V 150W

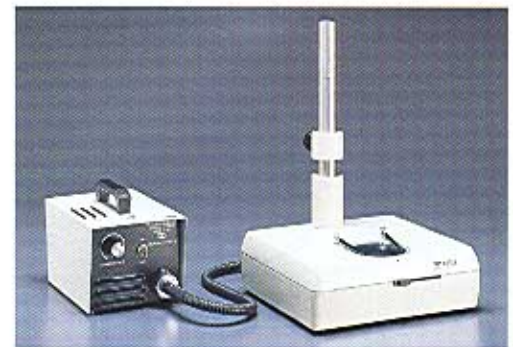

RZBD



Live shrimp (Neocaridina Sp) photographed under darkfield transmitted light

MAC UNIVERSAL STANDS

Universal boom stand for special applications involving large specimens. Features a 506mm vertical post with hand-operated crank for easy vertical positioning. The 460mm horizontal articulated arm with lockable joints allows the RZ to be swung easily into position. Available in three versions:

Model: MAC-1 without mounting post

Model: MAC-2 with fixed vertical mounting post

Model: MAC-3 with tilting mounting post

Base Dimensions: 305mm x 305mm x 38mm

Pillar Height: 483mm

Swing Arm: 445mm from column center to drop post center

Weight: 38.7kg (85 lbs)

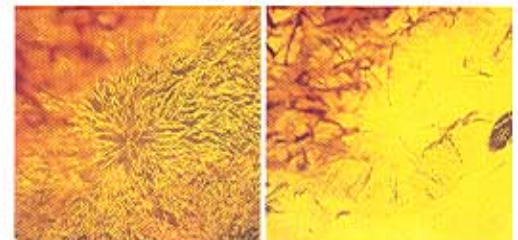

Crevice inside the Amber photographed under darkfield transmitted light

Crevice inside the Amber photographed under brightfield transmitted light



MAC-3

STAGES

GRADUATED MECHANICAL STAGE FOR RZP

This stage has 0.1mm graduations and coaxial controls for precise control of mounted specimens. Features 116mm x 137mm work surface with stage clips, 50mm x 75mm X-Y travel.

Catalog Number: MA578



MA578

GRADUATED MECHANICAL STAGE FOR RZT, RZBD, RZDT

This stage has 0.1mm graduations and coaxial controls for precise control of mounted specimens. Features 116mm x 137mm work surface with stage clips and 74mm x 96mm clear glass plate for use with transmitted light stands, 50mm x 75mm X-Y travel.

Catalog Number: MA578/05



MA578/05

UNGRADUATED SLIDING MECHANICAL STAGE FOR RZP

This stage features a 125mm x 170mm work surface with stage clips. Roller bearing mount allows smooth, easy, fingertip control over 100mm x 100mm X-Y travel.

Catalog Number: MA565

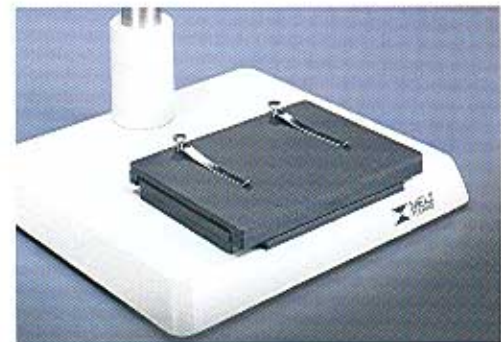

MA565

UNGRADUATED SLIDING MECHANICAL STAGE FOR RZT, RZBD, RZDT

This stage features a 125mm x 170mm work surface with stage clips and a 94.5mm diameter clear glass plate for use with transmitted light stands. Roller bearing mount allows smooth, easy, fingertip control over 100mm x 100mm X-Y travel.

Catalog Number: MA565/05



MA565/05

ZOOM STEREO MICROSCOPES

STAGES

POLARIZING STAGE FOR RZT, RZBD & RZDT

This is a 150mm diameter rotatable stage with vernier markings to 1°. Includes stage clips and 1/4 Wave plate in sliding mount. Optional First order red plate is also available.

Catalog Number: MA761

Optional First Order Red Plate: MA764

Polarizing Filter (Analyzer) for objective: MA550/15



MA761

SMALL SLIDING STAGE FOR THE MAC UNIVERSAL STAND

This stage features a work surface of 295mm x 295mm. Roller bearing mounts allow smooth and easy fingertip control. X-Y Travel: 195mm x 100mm.



Catalog Number: MA575

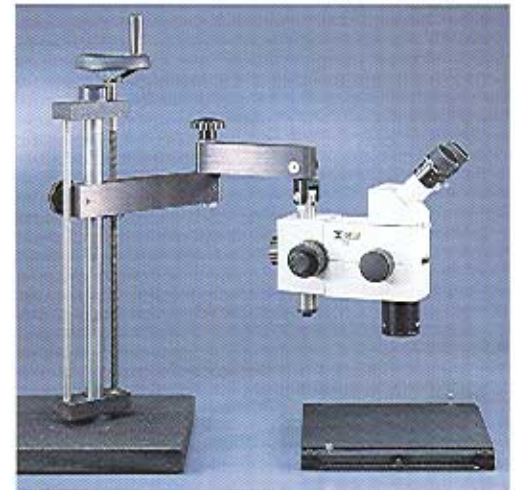

MA575 seen under RZ Stereo Microscope mounted on the MAC-3 Universal Stand

LARGE SLIDING STAGE FOR THE MAC UNIVERSAL STAND

This stage features a large work surface of 390mm x 335mm. Roller bearing mounts allow smooth and easy fingertip control. X-Y Travel: 350mm x 270mm



Catalog Number: MA574

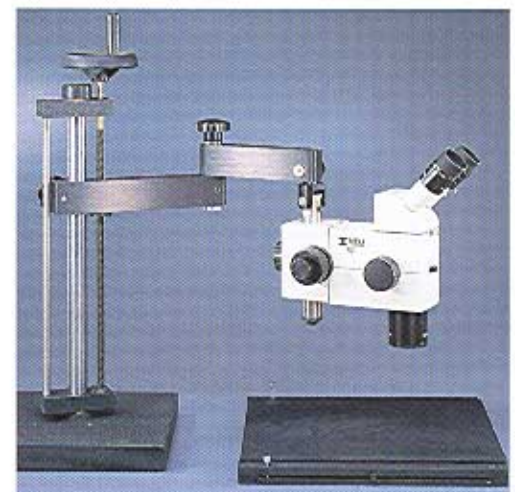

MA574 seen under RZ Stereo microscope mounted on the MAC-3 Universal Stand

ILLUMINATION

COAXIAL VERTICAL ILLUMINATOR

The coaxial vertical illuminator is used when observing flat, highly reflective specimens such as integrated circuits, semiconductor wafers, polished metal specimens, solder balls, or magnetic recording heads. The coaxial vertical illuminator mounts between the RZB body and the binocular viewing head and directs light from a 6V, 30W halogen lamp down through the objective onto the specimen. The coaxial illuminator is powered by an optional free-standing transformer (MA651/05 or MA651/10) or may be connected the rear of the RZT transmitted light base. Total magnification is increased by a factor of 1.5X when using the coaxial illuminator.

Model: COX

Replacement Bulb: MA326

1/4 WAVE PLATE

A 1/4 wave plate is required when using the coaxial vertical illuminator to view reflective specimens. The quarter wave plate is attached to the bottom of the objective and is rotated to achieve the desired effect.

Catalog Number: MA762

FILTER SETS

The following optional paired optical filter sets are available.

Catalog Numbers:

- | | |
|-------|---|
| MA754 | LB100 Blue clear filter in 18mm diameter mount |
| MA755 | G533 Green clear filter in 18mm diameter mount |
| MA756 | Y48 Yellow clear filter in 18mm diameter mount |
| MA757 | ND2 Neutral density filter in 18mm diameter mount |
| MA758 | ND8 Neutral density filter in 18mm diameter mount |



COX Coaxial vertical illuminator mounted on the RZP Stand model



COX Coaxial vertical illuminator mounted on the RZT Stand model

ZOOM STEREO MICROSCOPES

ILLUMINATION

OBLIQUE ILLUMINATION

A dual arm fiber optic illumination system is available for the RZ series stereo microscope. Composed of a 150W halogen light source, self-supporting dual arm light guides, connecting adapter and focusing lenses.

Model: FL181 Dual Arm Illumination System
Replacement Bulb: FL180/70

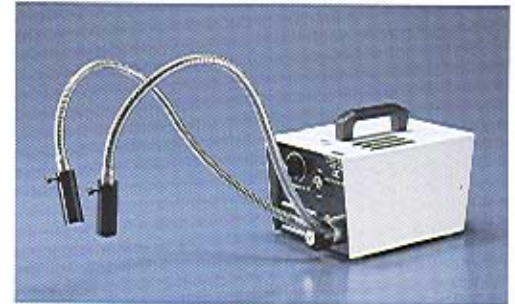

FL181

ANNULAR ILLUMINATION

An annular fiber optic light system is also available for the RZ series stereo microscope. Composed of a 150W halogen light source, connecting adapter and annular light guide.

Model: FL182 Annular Fiber Illumination System
Replacement Bulb: FL180/70

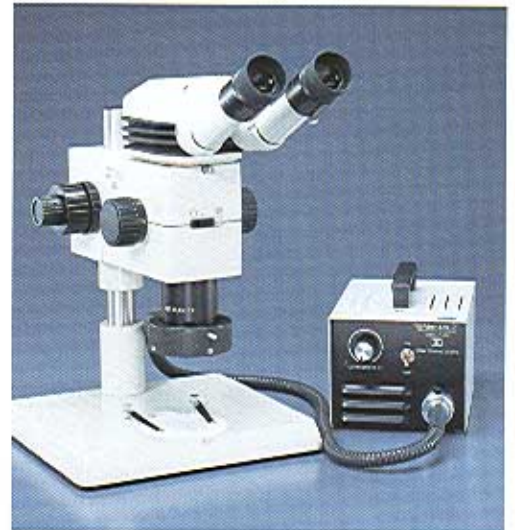

FL182 attached to the RZ Stereo microscope

FLUORESCENT RING ILLUMINATION

The MA305/100 (110V) or MA305/200 (220/240V) fluorescent ring illuminators provide cool, white diffuse illumination similar to daylight. Suitable for low magnification examination of delicate organisms that are sensitive to heat, or for specimens subject to surface reflection. The MA308 adapter is necessary to attach the MA305 illuminator to the RZ series microscope.

Fluorescent Ring Illumination System
Catalog Number: MA305/100 or MA305/200
Adapter: MA308
Replacement Bulb: MA305/05

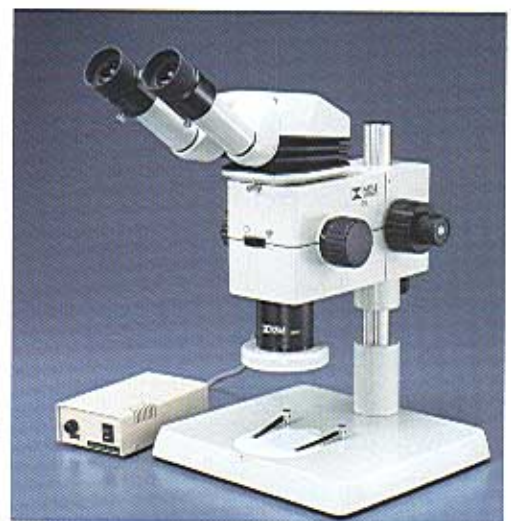

MA305 attached to the RZ Stereo microscope

PHOTOMICROSCOPY AND VIDEOMICROSCOPY PARTS AND ACCESSORIES



MA751

MA751 PHOTO/VIDEO ATTACHMENT

The primary component necessary for photo or video work with the RZ stereo microscope is the MA751 photo/video attachment. It allows you to take 35mm or large-format Polaroid photographs of your specimens, or to display your specimens on a video monitor. The MA751 photo/video attachment contains a beam-splitter prism which can be slid into the light path to redirect 80% of the light that would normally go to the eyepieces into the vertical photo tube behind the viewing head. This allows the user to view the specimen through the eyepieces while also taking photographs and/or displaying the image on a video monitor. (Note: Additional accessories are needed to attach 35mm or video cameras to the MA751: see below.)

MA752 AUXILIARY VIDEO ATTACHMENT

The MA752 auxiliary video attachment fits on the left side of the MA751 photo/video attachment and allows you to mount a video camera to the microscope. A standard "C" mount (MA151/10) for attaching a video camera is included with the MA752. Optional "C" mounts are also available and are listed below.

VIDEO "C" MOUNTS

"C" mounts are used to connect the video camera to the MA751 photo/video attachment and use projection lenses of various magnifications. Note: "C" mounts with reduction lenses (i.e. magnification factors less than 1.0X) are commonly used to compensate for the magnification increase inherent in CCD cameras and monitors.

Catalog Numbers:

MA151/35/04 with 0.45X lens

MA151/35/15 with 1.0X lens

MA151/35/20 with 0.7X lens

MA151/35/25 with 2.5X lens



"C" mount

ZOOM STEREO MICROSCOPES

Configuration:

- MA748 Standard viewing head
- RZ-B 10:1 Zoom body
- MA730 UWF10X Eyepieces (2)
- MA742 1.0X Plan Achromat Objective
- RZDT Brightfield/Darkfield Transmitted light Stand
- MA751 Photo/Video attachment
- MA752 Auxiliary Video attachment
- MA150/60 Camera attachment with finder
- CK3800 CCD Video camera
- 35mm SLR camera with T2 Adapter
- 14" screen color TV monitor



35mm PHOTOMICROSCOPY

Three parts are required for mounting a 35mm SLR camera body to the MA751 Photo/Video Attachment:

1. The appropriate T-2 adapter ring for your SLR camera body:

T2-1	Canon	T2-6	Olympus
T2-2	Minolta	T2-7	Contax, Yashica
T2-3	Pentax K	T2-8	Konica
T2-4	Pentax S (threaded)	T2-9	Canon EOS
T2-5	Nikon	T2-10	Minolta Alpha/Maxim 2000

These adapter rings attach directly to your camera body's lens mount.



T2 Adapter Ring

2. A photo eyepiece, available in the following magnifications:

MA512	2.5X magnification
MA500	3.3X magnification (with reticle mount)
MA508	5X magnification

The photo eyepiece performs the same function as a standard 35mm camera lens (i.e. focusing the image at the plane of the film).

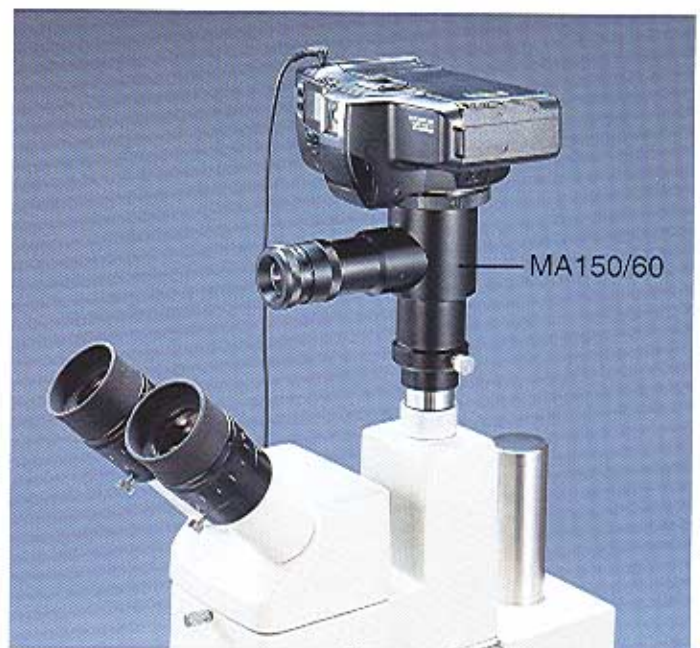

Photo Eyepiece

3. One of two MA150 series camera attachments:

MA150/50	Straight-tube camera attachment
MA150/60	Camera attachment with built-in focusing eyepiece

These are used to mount the camera/T2 assembly to the photo tube.



ZOOM STEREO MICROSCOPES

LARGE-FORMAT PHOTOGRAPHY

The MEIJI TECHNO PMX100 Large format photographic camera mounts directly to the photo tube of the RZ Photo/Video attachment and allows you to take high quality photographs of your specimen. The MEIJI PMX100 features a built-in 10X magnification factor and comes equipped with a 10X widefield focusing eyepiece and framing reticle.

The following equipment is required for large format photography:

1. The MEIJI PMX100 Large format photomicrographic camera.
2. A Film holder from the following sizes:
 - #405 3 1/4" x 4 1/4" pack film holder
 - #451 6cm x 9cm 8EX roll film holder
 - #452 6cm x 7cm 10EX roll film holder
 - #453 6cm x 9cm 16EX roll film holder
 - #545 4" x 5" sheet film holder
 - #550 4" x 5" pack film holder
3. Film to fit the above film holder.

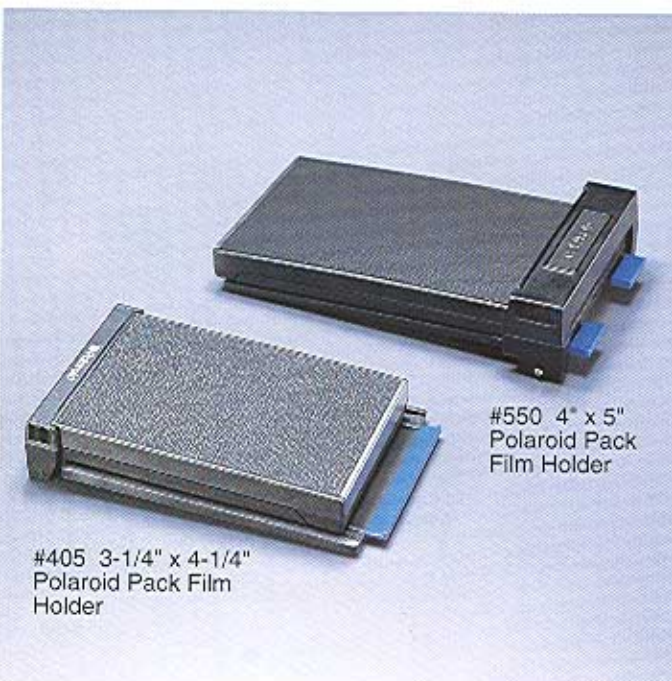

PMX100 Large format photographic camera with #405 Polaroid pack film holder attached to the MA751 mounted on the RZ Stereo microscope

DRAWING AND MEASURING COMPONENTS

MA765 DRAWING ATTACHMENT

Although photographs and digital images are used for many applications where line drawings have formerly been used, skill in creating high quality line drawings of microscopic specimens will always be an asset. Not only are line drawings more economical to publish than photo or video images, they also allow the drawer to clearly render multiple layers of an object that cannot otherwise be brought into focus simultaneously. The MEIJI MA765 drawing attachment for the RZ series gives you the power to create high quality detailed images of your most demanding specimens.



MA765 Drawing attachment mounted on the RZ Stereo microscope

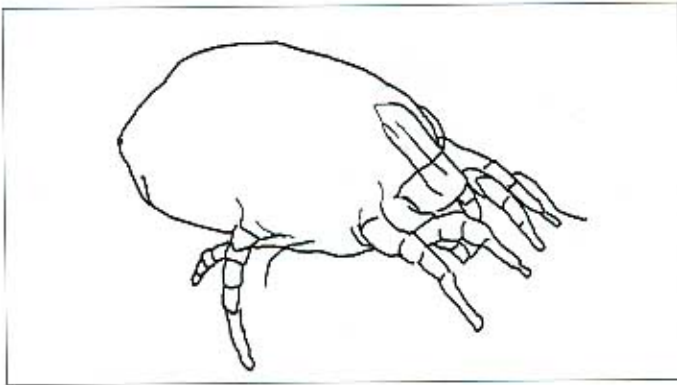

EYEPIECE MICROMETERS

Eyepiece micrometers can be inserted into the 10X, 15X or 20X eyepieces for the purpose of specimen measurement. Linear scales, counting grids, and crossline micrometers are just a few of the choices available to facilitate measurement of your specimens.

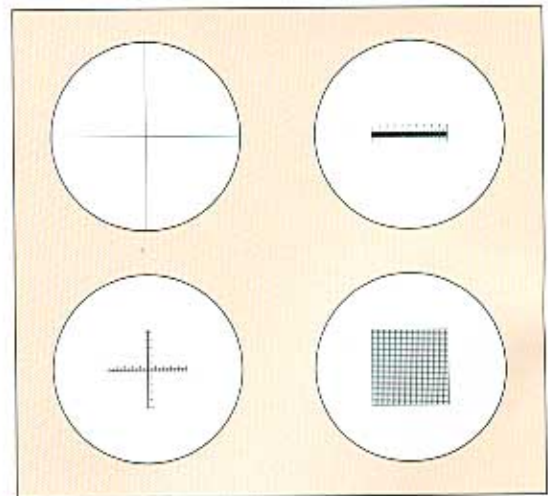

STAGE MICROMETERS

Stage micrometers are used to calibrate the eyepiece micrometers. Stage micrometers are available with both English and metric scales for reflected and transmitted light.

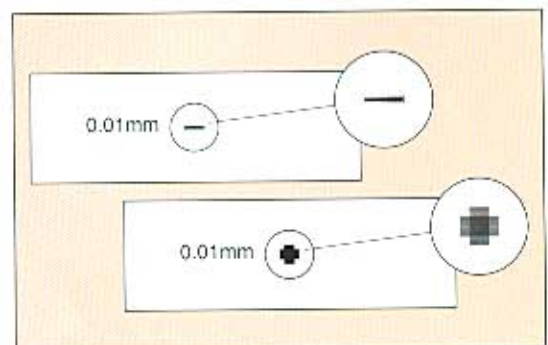

ZOOM STEREO MICROSCOPES

RZ Series MAGNIFICATION AND FIELD OF VIEW

		PLANACHROMAT OBJECTIVES									
		1.0X		0.5X		0.75X		1.5X		2.0X	
		Working Distance		Working Distance		Working Distance		Working Distance		Working Distance	
		76mm		164mm		101mm		43mm		29mm	
Eyepiece Mag.	Zoom Indicator	Total Mag.	Field Diameter	Total Mag.	Field Diameter	Total Mag.	Field Diameter	Total Mag.	Field Diameter	Total Mag.	Field Diameter

UWF 10X Field No.24	0.75	7.5X	32	3.75X	64	5.62X	42.7	11.25X	21.3	15.0X	16
	1	10.0X	24	5.0X	48	7.5X	32	15.0X	16	20.0X	12
	1.5	15.0X	16	7.5X	32	11.25X	21.3	22.5X	10.7	30.0X	8
	2	20.0X	12	10.0X	24	15.0X	16	30.0X	8	40.0X	6
	2.5	25.0X	9.6	12.5X	19.2	18.75X	12.8	37.5X	6.4	50.0X	4.8
	3	30.0X	8	15.0X	16.0	22.5X	10.7	45.0X	5.3	60.0X	4
	3.5	35.0X	6.9	17.5X	13.7	26.25X	9.1	52.5X	4.6	70.0X	3.4
	4	40.0X	6	20.0X	12	30.0X	8	60.0X	4.0	80.0X	3
	5	50.0X	4.8	25.0X	9.6	37.5X	6.4	75.0X	3.2	100.0X	2.4
	6	60.0X	4	30.0X	8	45.0X	5.3	90.0X	2.7	120.0X	2
7	70.0X	3.4	35.0X	6.9	52.5X	4.6	105.0X	2.3	140.0X	1.7	
7.5	75.0X	3.2	37.5X	6.4	56.25X	4.3	112.5X	2.1	150.0X	1.6	

UWF 15X Field No.16	0.75	11.25X	21.3	5.62X	42.7	8.43X	28.4	16.87X	14.2	22.5X	10.7
	1	15.0X	16	7.5X	32	11.25X	21.3	22.5X	10.7	30.0X	8
	1.5	22.5X	10.7	11.25X	21.3	16.87X	14.2	33.75X	7.1	45.0X	5.3
	2	30.0X	8	15.0X	16	22.5X	10.7	45.0X	5.3	60.0X	4
	2.5	37.5X	6.4	18.75X	12.8	28.12X	8.5	56.25X	4.3	75.0X	3.2
	3	45.0X	5.3	22.5X	10.7	33.75X	7.1	67.5X	3.6	90.0X	2.7
	3.5	52.5X	4.6	26.2X	9.1	39.37X	6.1	78.75X	3	105.0X	2.3
	4	60.0X	4	30.0X	8	45.0X	5.3	90.0X	2.7	120.0X	2
	5	75.0X	3.2	37.5X	6.4	56.25X	4.3	112.5X	2.1	150.0X	1.6
	6	90.0X	2.7	45.0X	5.3	67.5X	3.6	135.0X	1.8	180.0X	1.3
7	105.0X	2.3	52.5X	4.6	78.7X	3	157.5X	1.5	210.0X	1.1	
7.5	112.5X	2.1	56.25X	4.3	84.37X	2.8	168.7X	1.4	225.0X	1	

UWF 20X Field No.12	0.75	15.0X	16	7.5X	32	11.25X	21.3	22.5X	10.7	30.0X	8
	1	20.0X	12	10.0X	24	15.0X	16	30.0X	8	40.0X	6
	1.5	30.0X	8	15.0X	16	22.5X	10.7	45.0X	5.3	60.0X	4
	2	40.0X	6	20.0X	12	30.0X	8	60.0X	4	80.0X	3
	2.5	50.0X	4.8	25.0X	9.6	37.5X	6.4	75.0X	3.2	100.0X	2.4
	3	60.0X	4	30.0X	8	45.0X	5.3	90.0X	2.7	120.0X	2
	3.5	70.0X	3.4	35.0X	6.9	52.5X	4.6	105.0X	2.3	140.0X	1.7
	4	80.0X	3	40.0X	6	60.0X	4	120.0X	2	160.0X	1.5
	5	100.0X	2.4	50.0X	4.8	75.0X	3.2	150.0X	1.6	200.0X	1.2
	6	120.0X	2	60.0X	4	90.0X	2.7	180.0X	1.3	240.0X	1
7	140.0X	1.7	70.0X	3.4	105.0X	2.3	210.0X	1.1	280.0X	0.9	
7.5	150.0X	1.6	75.0X	3.2	112.5X	2.1	225.0X	1	300.0X	0.8	

RZ Series MODEL AND CATALOG NUMBERS

BODY:

RZ-B Zoom Body with focusing block, 10:1 Zoom ratio, with built-in iris diaphragm and click stops

EYEPIECES:

MA730 UWF10X Eyepiece, High-eyepoint, focusable, FN24 (pc) (Receives 25mm diameter reticle)
MA731 UWF10X Eyepiece, High-eyepoint, focusable, w/cross, FN 24 (pc) (Receives 25mm diameter reticle)
MA732 UWF15X Eyepiece, High-eyepoint, focusable, FN 17 (pc) (Receives 19mm diameter reticle)
MA733 UWF15X Eyepiece, High-eyepoint, focusable, w/cross, FN 17 (pc) (Receives 19mm diameter reticle)
MA734 UWF20X Eyepiece, High-eyepoint, focusable, FN 12 (pc) (Receives 19mm diameter reticle)
MA735 UWF20X Eyepiece, High-eyepoint, focusable, w/cross, FN 12 (pc) (Receives 19mm diameter reticle)

OBJECTIVES:

MA740 Plan Achromat Objective 0.5X for RZ-B, W.D. 164.0mm
MA741 Plan Achromat Objective 0.75X for RZ-B, W.D. 107.0mm
MA742 Plan Achromat Objective 1.0X for RZ-B, W.D. 78.5mm
MA743 Plan Achromat Objective 1.5X for RZ-B, W.D. 43.0mm
MA744 Plan Achromat Objective 2.0X for RZ-B, W.D. 29.0mm

VIEWING HEADS:

MA748 RZ Binocular head, 45°
MA749 RZ Binocular head, Ergonomic type, vertically adjustable from 10° to 50°

PHOTO/VIDEO ATTACHMENTS:

MA751 RZ Photo tube attachment with 80/20 beam-splitter
MA752 Video camera attachment (Requires MA751)

STANDS:

RZP Plain stand with white & black plastic stage plate, 12.79" (325mm) Pillar
RZT/100 Stand with transmitted illumination system, 6V, 30W Halogen, 12.79" (325mm) Pillar, main voltage 110/120V
RZT/200 Stand with transmitted illumination system, 6V, 30W Halogen, 12.79" (325mm) Pillar, main voltage 220/240V
RZBD/100 Stand with brightfield/darkfield transmitted illumination system, includes an annular fiber optic light guide and an external 150W halogen light source, 110/120V
RZBD/200 Stand with brightfield/darkfield transmitted illumination system, includes an annular fiber optic light guide and an external 150W halogen light source, 220/240V
RZDT/100 Stand with brightfield/darkfield transmitted illumination system, with 6V, 30W Halogen light source. A second 6V, 30W transformer is built in for use with optional oblique illuminators, 110/120V
RZDT/200 Stand with brightfield/darkfield transmitted illumination system, with 6V, 30W Halogen light source. A second 6V, 30W transformer is built in for use with optional illuminators, 220/240V
MAC-1 Universal stand without mounting post. Pillar Height: 483mm. Swing arm: 445mm from column center to drop post center.
MAC-2 Universal stand with fixed vertical mounting post for RZ-B Zoom Body. Pillar Height: 483mm. Swing arm: 445mm from column center to drop post center.
MAC-3 Universal stand with tilting mounting post for RZ-B Zoom Body. Pillar Height: 483mm. Swing arm: 445mm from column center to drop post center.

ILLUMINATORS:

COX Coaxial vertical illuminator w/o transformer, 6V, 30W Halogen
(Requires MA762 1/4 wave plate in mount for use with RZ Plan Objective)
MA754 Filter for COX illuminator, LB100, blue clear in 18mm diameter mount
MA755 Filter for COX illuminator, G533 green clear in 18mm diameter mount
MA756 Filter for COX illuminator, Y48 yellow clear in 18mm diameter mount

ZOOM STEREO MICROSCOPES

MA757	Filter for COX illuminator, ND2, neutral density in 18mm diameter mount
MA758	Filter for COX illuminator, ND8, neutral density in 18mm diameter mount
MA651/05	Transformer only, main voltage 115V, sec. 6V, 30W (for COX)
MA651/10	Transformer only, main voltage 220/240V, sec. 6V, 30W (for COX)
FL180A	Light source for 110/120V, 50/60Hz operation, halogen lamp 21V, 150W with light-intensity regulation, maximum color temperature 3,200°K, with fan
FL180B	Light source for 220/240V, 50/60Hz operation, halogen lamp 21V, 150W with light-intensity regulation, maximum color temperature 3,200°K, with fan
FL180/10	Annular light guide, 60mm (2.36") diameter ring aperture, 9.5mm (0.37") diameter fiber bundle
FL180/40	Adapter, 16.0mm (0.629") aperture (for use with the FL180/10 and FL180)
FL180/70	Halogen lamp, 21V, 150W for FL180 Light source
MA305/100	Ring fluorescent illuminator with starter, 110V (Requires MA308 adapter)
MA305/200	Ring fluorescent illuminator with starter, 220/240V (Requires MA308 adapter)
MA305/05	Ring fluorescent tube, daylight, 8W, 6,500°K for MA305/100 and MA305/200
MA308	Adapter to mount MA305 on Plan Achromat Objective
MA326	Spare Halogen lamp, 6V, 30W for RZT, RZDT and COX

STAGES AND STAGE COMPONENTS:

MA578	Coaxial controlled graduated mechanical stage for RZP stand, 50mm x 75mm movement
MA578/05	Coaxial controlled graduated mechanical stage with clear glass plate for RZT, RZDT and RZBD Stands, 50mm x 78mm movement
MA565	Ungraduated sliding mechanical stage, 100mm x 100mm movement for RZP Stand
MA565/05	Ungraduated sliding mechanical stage with clear glass plate for RZT, RZDT and RZBD Stands, 100mm x 100mm movement
MA574	Large sliding stage with 390mm x 335mm work surface. Black anodized, roller-bearing movement, X-Y travel 350mm x 270mm (13.78" x 10.63")
MA575	Small sliding stage with 292mm x 236mm work surface. Black anodized, roller-bearing movement, X-Y travel 200mm x 100mm (8" x 4")
MA761	Rotatable stage with polarizer and 1/4 wave plate in sliding mounts, reading to 1° rotation, 150mm diameter for RZT, RZDT and RZBD Stands
MA761/05	Thin spection plate (use with MA761 when viewing thin sections)
MA762	1/4 Wave plate for use with COX illuminator
MA763	Replacement polarizer in sliding mount for use with MA761
MA764	1st Order Red compensating plate in sliding mount for use with MA761
MA771	Replacement 1/4 Wave plate in sliding mount for use with MA761
MA567	Acrylic stage plate, frosted, 94.5mm diameter for RZT, RZDT and RZBD Stands
MA568	Black and white plastic stage, 94.5mm diameter for RZP Stand
MA569	Glass stage plate, clear, 94.5mm diameter for RZT, RZDT and RZBD Stands

OTHER COMPONENTS:

MA765	Drawing Attachment
MA550/15	Polarizing filter (Analyzer) in mount for RZ Plan Objective
MA667	Polarizing plate (Polarizer) for use with RZT Stand (Recommended to use with the MA550/15)
MA555	Gem Clamp
MA593	Stage clips (paired)
MA688	Pillar only, 500mm long
MA767	Blue clear filter for RZT, RZDT and RZBD, 59.8mm diameter
MA766	Heat protecting filter for RZT, RZDT and RZBD, 59.8mm diameter

SAMPLE SYSTEM CONFIGURATIONS

Configuration No. RZ-1

- MA748 Binocular Viewing Head, 45°
- RZ-B 10:1 Zoom Body with built in dual-iris diaphragm and click stops
- MA730 UWF 10X Eyepieces (2)
- MA742 1.0X Plan Achromat Objective
- RZP Plain Stand

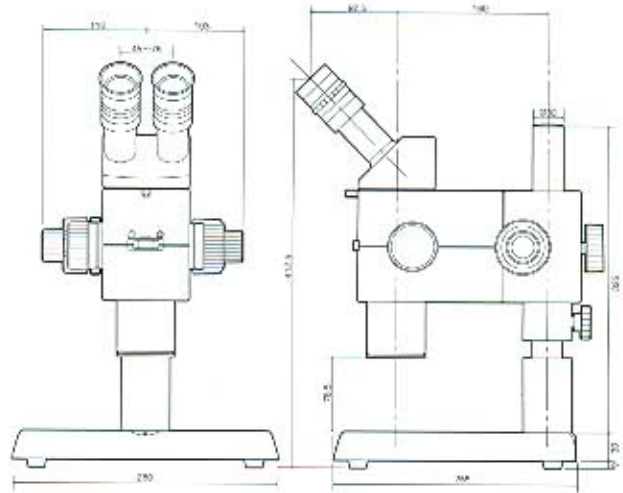

Configuration No. RZ-2

- MA749 Ergonomic Viewing Head, 10° to 50°
- RZ-B 10:1 Zoom Body with built in dual-iris diaphragm and click stops
- MA730 UWF 10X Eyepiece (2)
- MA742 1.0X Plan Achromat Objective
- RZP Plain Stand

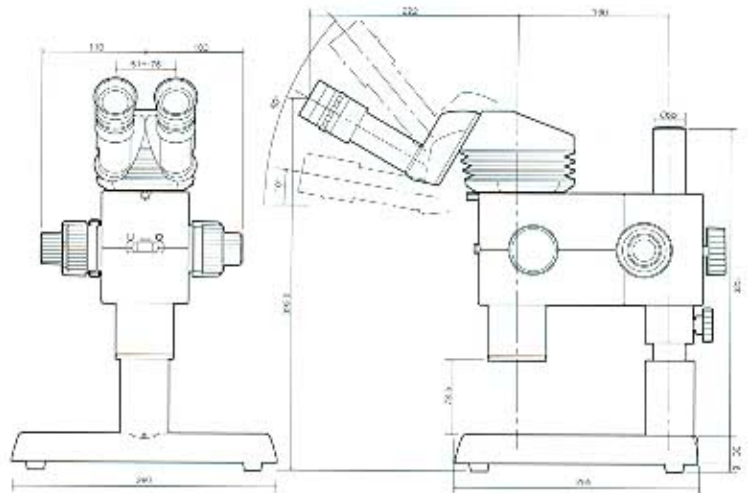

ZOOM STEREO MICROSCOPES

SAMPLE SYSTEM CONFIGURATIONS

Configuration No. RZ-3

- MA748 Binocular Viewing head, 45°
- RZ-B 10:1 Zoom Body with built in dual-iris diaphragm and click stops
- MA730 UWF 10X Eyepieces (2)
- MA742 1.0X Plan Achromat Objective
- RZT Transmitted light Stand (6V, 30W)

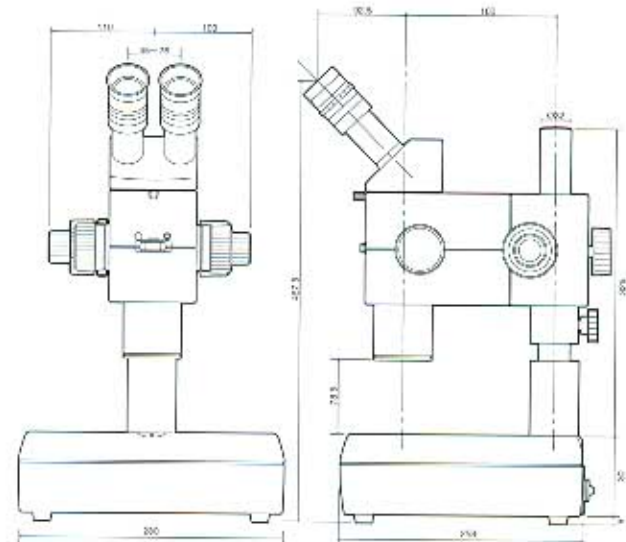

Configuration No. RZ-4

- MA749 Ergonomic Viewing Head, 10° to 50°
- RZ-B 10:1 Zoom Body with built in dual-iris diaphragm and click stops
- MA730 UWF 10X Eyepieces (2)
- MA742 1.0X Plan Achromat Objective
- RZT Transmitted light Stand (6V, 30W)

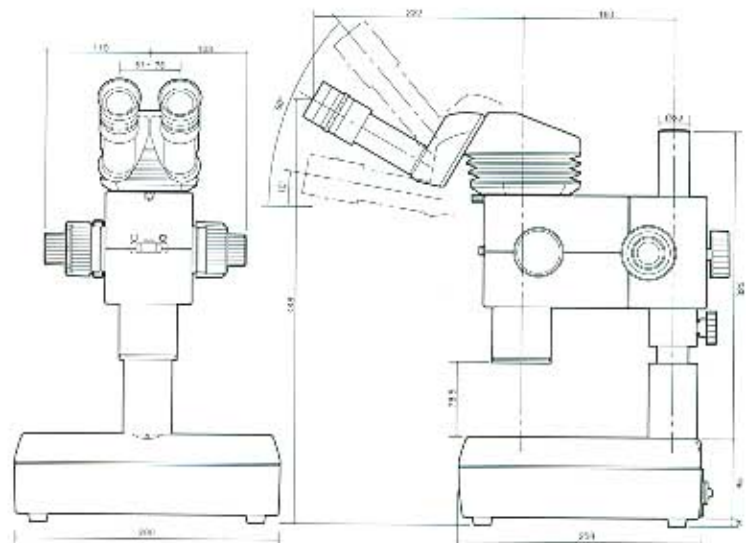
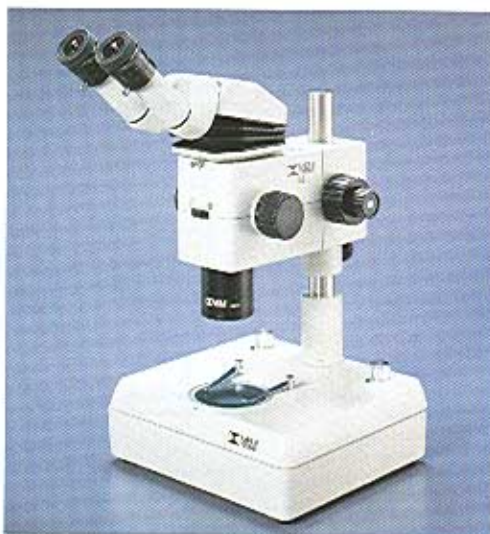

ZOOM STEREO MICROSCOPES

SAMPLE SYSTEM CONFIGURATIONS

Configuration: Optional

MA749	Ergonomic Viewing Head
MA730	UWF10X Eyepieces (2)
RZ-B	10:1 Zoom Body with built in dual-iris diaphragm
MA742	1.0X Plan Achromat Objective
RZDT	Brightfield/Darkfield Transmitted light Stand
MA751	Photo/Video Attachment
MA752	Video camera Attachment
PMX-100	Large Format Camera
CK3800	CCD Video Camera TV monitor

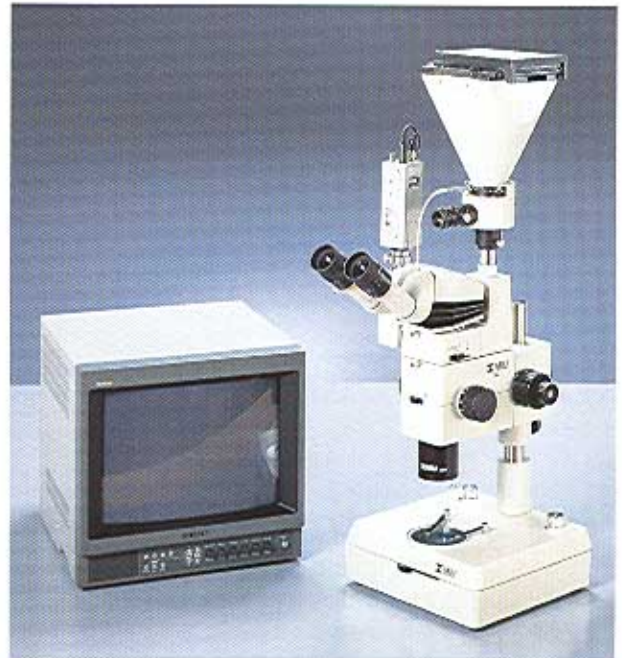

Configuration: Optional

MA749	Ergonomic Viewing Head
MA730	UWF10X Eyepieces (2)
RZ-B	10:1 Zoom Body with built in dual-iris diaphragm
MA742	1.0X Plan Achromat Objective
RZT	Brightfield Transmitted light Stand
MA751	Photo/Video Attachment
MA752	Video camera Attachment
PMX-100	Large Format Camera
FL182	Annular fiber optic illumination system

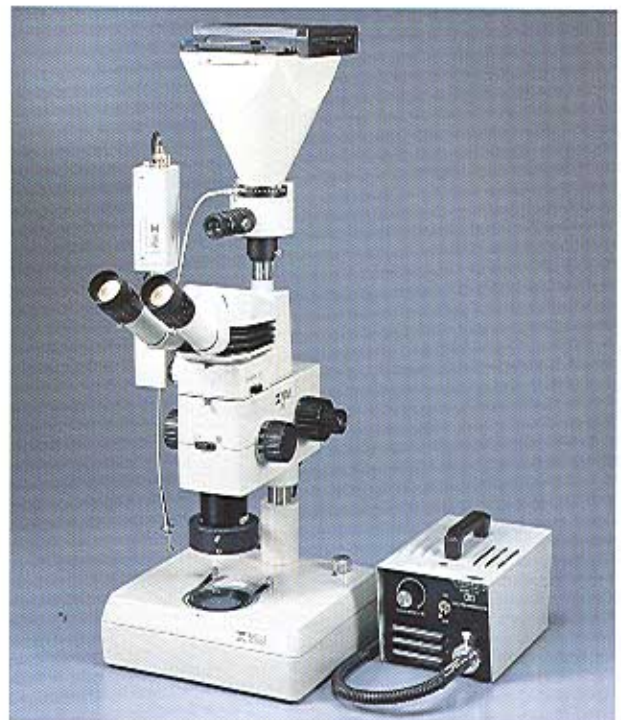

RZ SYSTEM DIAGRAM

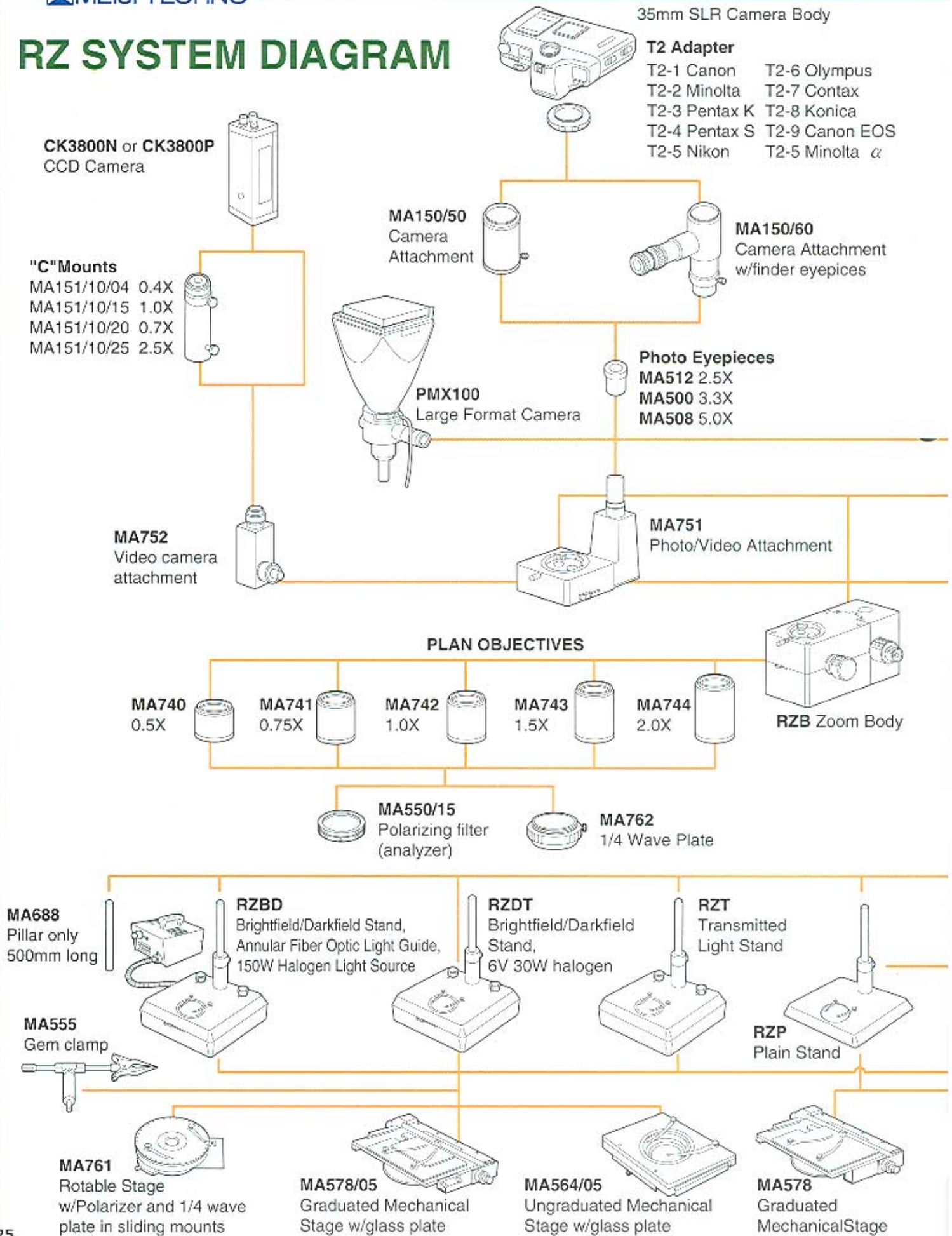

MA730
UWF10X
Eyepiece



MA731
UWF10X
Eyepiece
w/crossline



MA732
UWF15X
Eyepiece



MA733
UWF15X
Eyepiece
w/crossline



MA734
UWF20X
Eyepiece



MA735
UWF20X
Eyepiece
w/crossline



**CK3800N or
CK3800P**
CCD Video Camera



MA748
45° Binocular Head



MA749
Ergonomic Binocular
Head



"C" Mounts
MA151/35/04 0.4X
MA151/35/15 1.0X
MA151/35/20 0.7X
MA151/35/25 2.5X



Optional Filters for COX
MA754 LB100 Clear Blue
MA755 G533 Clear Green
MA756 Y48 Clear Yellow
MA757 ND2 Neutral Density
MA758 ND8 Neutral Density



MA765 Drawing Attachment

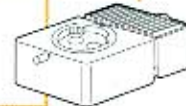

COX Coaxial
Illuminator



MA651/05 or MA651/15
Optional Power Supply
for COX

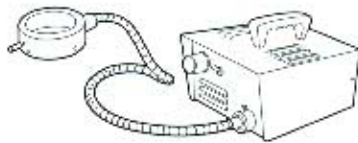

FL182
Annular Fiber Optic
Illumination System

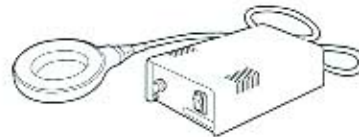

MA305
Fluorescent Ring Light

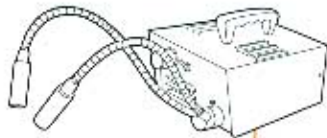

FL181
Dual arm fiber illumination
System



MA308
Adapter for MA305



MA568
B/W Plastic Stage
Plate



MA567
Acrylic Frosted Stage
Plate



MA569
Glass Stage
Plate

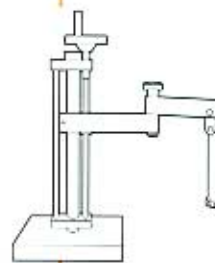

MAC-1
Universal Stand w/Straight
Mounting Post

MAC-2
Universal Stand w/Inclinable
Mounting Post



MA565
Ungraduated Mechanical
Stage



MA575
Sliding Stage with
200mm x 100mm, X-Y travel



MA574
Sliding Stage with
350mm x 270mm, X-Y travel



MEIJI TECHNO CO.,LTD.

6, Oi-670, Oi-machi, Iruma-gun

Saitama 356-0053, Japan

Phone : 492-67-0911

Fax : 492-69-0691, 492-69-0692

MEIJI TECHNO AMERICA

2186 Bering Drive

San Jose, CA., 95131, USA

Phone : 408-428-9654 Fax : 408-428-0472

Toll free : 800-832-0060

<http://www.meijitechno.com>